

926M, 930M, 938M

Wheel Loaders



	926M	930M	938M
Engine Model*	Cat® C7.1 ACERT™	Cat C7.1 ACERT	Cat C7.1 ACERT
Maximum Rated Gross Power:			
ISO 14396	114 kW (153 hp)	122 kW (164 hp)	140 kW (188 hp)
ISO 14396 (DIN)	114 kW (155 hp)	122 kW (166 hp)	140 kW (190 hp)
Bucket Capacity	1.9-5.0 m ³ (2.5-6.5 yd ³)	2.1-5.0 m ³ (2.7-6.5 yd ³)	2.5-5.0 m ³ (3.3-6.5 yd ³)
Full Turn Tip Load	7524 kg (16,587 lb)	8469 kg (18,670 lb)	10 028 kg (22,107 lb)
Operating Weight	13 050 kg (28,770 lb)	14 007 kg (30,879 lb)	16 427 kg (36,216 lb)

*Engine meets U.S. EPA Tier 4 Final/EU Stage IV emission standards.

Making Your Choice Easy

Efficiently Powerful

Experience Hybrid like fuel efficiency with an intelligent hydrostatic power train and industry leading fuel savings. For your toughest and most demanding applications a new Performance Mode will boost the power and hydraulic speed.

Work Made Easy

Move more with Caterpillar's patented quick loading Performance Series buckets and optimized Z-bar linkage. The parallel lift and high tilt forces allow you to safely handle loads. Multi-function work has never been easier with dedicated pumps and a flow sharing implement valve.

Enjoy All Day Comfort

Have a seat in the M Series Small Wheel Loader and enjoy, whisper quiet sound levels, all around visibility and seat mounted joystick controls. The large spacious cab combined with Caterpillar's exclusive hydraulic cylinder damping make this the most comfortable seat on your job site.

Customize Your Experience

Meet your application requirements and individual preferences with Caterpillar's industry first Power Train Modes. Fine tune machine performance with adjustments at your fingertips through soft touch buttons and secondary display.

Configured for Success

A complete range of optional equipment gives you the versatility to configure an M Series Small Wheel Loader to be successful in your business.

Contents

Efficiently Powerful.....	4
Work Made Easy	6
Enjoy All Day Comfort.....	8
Customize Your Experience.....	10
Configured for Success	11
Service.....	12
Customer Support.....	12
Wheel Loader Specifications	13
Bucket Specifications	18
Bucket Selection Tables	24, 31
Operating Specifications	28
Supplemental Specifications	33
Standard and Optional Equipment	35



Environmental and customer friendly – up to 95% recyclable content by weight



The Cat 926M, 930M and 938M Small Wheel Loaders set the standard for productivity, fuel efficiency and operator comfort. The improved optimized Z-bar loader linkage delivers the quick loading performance of a traditional Z-bar with the parallelism and load handling capability of a tool carrier. A high torque, low speed C7.1 ACERT engine works in concert with an intelligent hystat power train to deliver fuel efficiency as standard. Meets Tier 4 Final/Stage IV emission standards with an environmentally friendly, Clean Emission Module designed to manage itself so you can concentrate on your work. Experience the new industry benchmark.



Efficiently Powerful

Experience hybrid-like fuel efficiency with more power when you need it.

Intelligent Power Management

The Caterpillar exclusive Intelligent Power Management system has been further enhanced to monitor operator input and power availability to keep the machine working at peak efficiency and provide the operator with greater customization to suit their application.

Power on Demand

A choice of Power Modes allows you to choose between maximum fuel efficiency or boosted power along with hydraulic speed.



Standard Power Mode

- Saves up to 10% fuel compared to K Series Cat loader.
- Delivers equal performance compared to K Series Cat Loader.
- Reduces cab sound levels down to a whisper quiet 64 dB(A) typical.
- Biggest gains seen during load and carry, snow removal and roading applications.

Performance Power Mode

- Enabled at the push of a button (HP+).
- Boosts engine power by up to 10% and engine speed by over 12%.
- Increases hydraulic cycle times and productivity.

Six Cylinders of Efficient Power

The Cat C7.1 ACERT engine provides cleaner, quieter operation while delivering superior performance and durability through a high torque, low speed design. The engine meets Tier 4 Final and Stage IV emission standards with a Clean Emissions Module that is designed to manage itself so you can concentrate on your work.

- **No downtime for regeneration** with a passive low temperature system that keeps you on the job.
- **Fit for Life Diesel Particulate Filter (DPF)** that is designed to exceed the engine overhaul life.
- **Extended fluid fill intervals** with minimal use of Diesel Exhaust Fluid (DEF) also referred to as Adblue™ with up to four fuel tank fills per DEF fill.
- **Configurable auto idle shut down** based on time and ambient temperature to further reduce fuel burn and keep operating costs low.



Power to the Ground

Lock up and go with fully locking front differential axles that can be engaged on the move at full torque with the pull of a trigger on the seat mounted joystick. Maximize your traction with optional Limited Slip Differential on the rear axle to keep you climbing.

Independent service brakes on front and rear axles provide robust stopping performance while a push button electronic park brake allows you to safely secure the machine with ease.

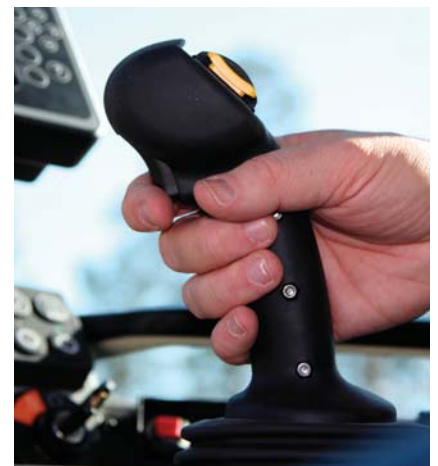

Work Made Easy

Getting the job done.



Optimized Z-bar Linkage

The Caterpillar patented optimized Z-bar linkage combines the digging efficiency of a traditional Z-bar with integrated tool carrier capabilities for great performance and versatility.

- **Perfect Parallelism** functionality available in Fork Mode gives truly predictable performance while high tilt forces throughout the working range help you safely and confidently handle loads with precise control.
- **Visibility** to bucket corners and fork tips at ground level remain excellent while sight lines at maximum lift are improved with a Generation II lift arm design.
- **Lift higher and reach further** with optional High Lift linkage available on all three models.

Quick Loading Performance Series Buckets

Performance Series Buckets deliver up to 10% higher fill factors and better material retention for significant productivity and fuel efficiency improvements. The buckets feature a longer floor to take a bigger bite of the pile, an open throat to heap higher and curved side bars to help with material retention. This optimized shape is echoed across the General Purpose, Light Material and High Dump bucket families.



Smooth and Predictable Multi-Function Performance

M Series machines feature an electro-hydraulic control system that is governed by the Intelligent Power Management system for peak efficiency. The load-sensing, variable flow system senses work demand and adjusts flow and pressure to match the operators request.

- **Multi-Function without compromise** through dedicated hydraulic systems featuring one pump for the Intelligent Hydrostatic drive, a 2nd pump for the implements, and a 3rd pump for the steering system. Drive, Lift and Steer simultaneously with smooth predictable control. The M Series simply does what you ask it to.
- **Programmable in-cab kick-outs** are easy to set on the go for tilt, lower and lift. This feature is ideal for applications where the work cycle is repeatable allowing you to quickly return to programmed set points such as ground and level.
- **Fine tune hydro-mechanical performance** with fully adjustable 3rd and 4th function flow through the secondary display (when equipped) for a perfect marriage between machine and work tool.





Enjoy All Day Comfort

Best seat on your job site.

Have a Seat and Experience:

- **Seat-mounted controls** featuring a low effort joystick for lift and tilt functions along with integrated Forward/Neutral/Reverse switch, differential lock trigger and optional third and fourth auxiliary functions.
- **Superior all around visibility** with single piece front windshield, new parabolic external mirrors, redesigned Generation II linkage and clean hydraulic lines routing.
- **Automatic climate control** with heated rear glass and external mirrors for a quick defrost.
- **Fully adjustable controls** including steering column, joystick and seat suspension.
- **Information at a glance** with large primary LCD display and optional secondary display.
- **An extra eye on the job site** with optional rearview camera and integrated object detection.
- **A heated and cooled seat option** for added comfort in a wide range of climates.



Enjoy coming to work with:

- **A spacious, safe, quiet operator environment** featuring ergonomic controls, seat belt notification and optional bluetooth radio with integrated microphone plus an MP3 port.
- **Easy access to vital machine parameters** with the optional* secondary display that works in conjunction with the standard soft touch panel to allow real time adjustments to machine features and an integrated help button with over 25 languages.
- **Comfortable soft stops at cylinder end stroke** conditions and programmed kick-out points with Caterpillar's exclusive electro-hydraulic cylinder snubbing.
- **An even smoother ride** with optional Ride Control when working unloaded and loaded with excellent material retention.
- **Early starts and late finishes** are made easier with optional LED lighting package that includes engine compartment lighting to illuminate the way for checking oil, and coolant level along with re-fueling the machine in dark conditions.



**Standard in Europe*



Customize Your Experience

Make it yours.

Work as one with your machine by customizing controls.

Flexible Power Train

A smooth, step-less electronically controlled hydrostatic transmission provides adjustable power to the ground with excellent groundspeed control and customizable feel.

- **Select your Power Train Mode:**
 - Torque Converter (TC) for smooth rollout.
 - Hystat for aggressive engine braking.
 - Ice to maximize control on snow and ice.
 - Default which blends the best of Hystat and Torque Converter characteristic.
- **Reduce tire wear** using Rimpull control which enables you to match available tractive power to underfoot conditions.
- **Fine tune ground speed** when using work tools such as brooms, snow blowers and brush cutters with Creeper Control.
- **Set Directional Shift Response**, soft and smooth for material handling applications or sharp for aggressive operation.



Adjustable Electro-Hydraulic Controls

Easily customize hydraulic performance to meet your needs.

- **Optimize hydraulic modulation** with Fine Mode control when working with forks, material handling arms, and large tools.
- **Quicker hydraulic response** for fine grading at speed and agriculture applications through Lift and Tilt response settings.
- **Fully adjustable ride control** activation speed along with 3rd and 4th function auxiliary flows.

Operator Profiles and Coded Start

- The M Series Wheel Loaders will remember you and your personal settings with unique operator codes to make this machine truly yours and keep it secure.

Configured for Success

Ready to work for you.

The Way You Want It

A complete range of optional equipment and work tools give you the versatility to configure an M Series wheel loader to be successful in your business. Get with your Cat dealer to configure yours.

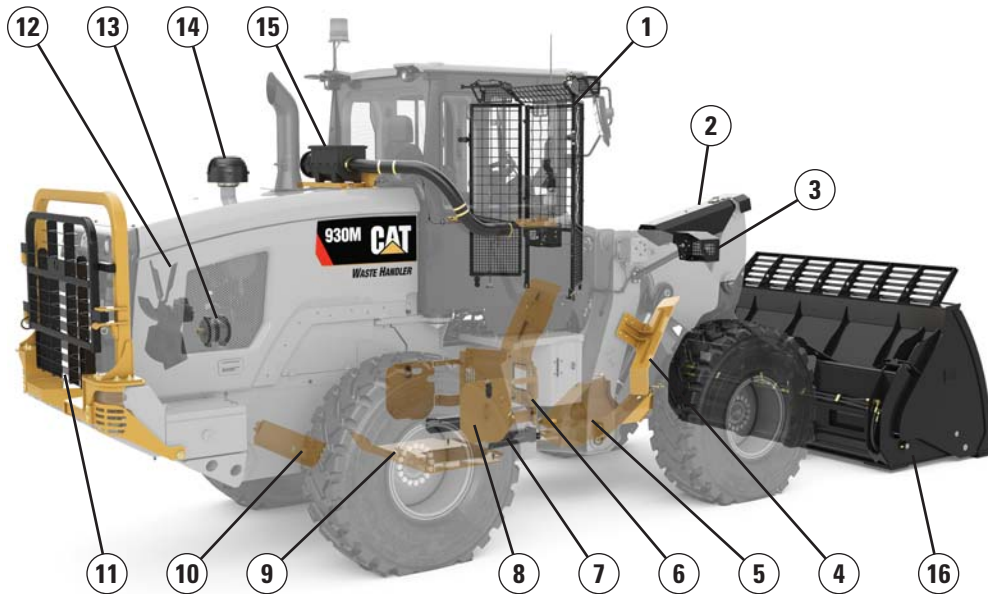

Guards:

- 1) Windshield
- 2) Tilt cylinder
- 3) Lights
- 4) Fender deflectors
- 5) Drive shaft
- 6) Hitch
- 7) Steering cylinders
- 8) Side power train
- 9) Lower power train
- 10) Crank case
- 11) Rear radiator (930M and 938M only)

Debris Packages:

- 12) Reversing fan
- 13) Sealed alternator
- 14) Turbine precleaner
- 15) RESPA precleaner

Work Tools:

- 16) Full range of attachments

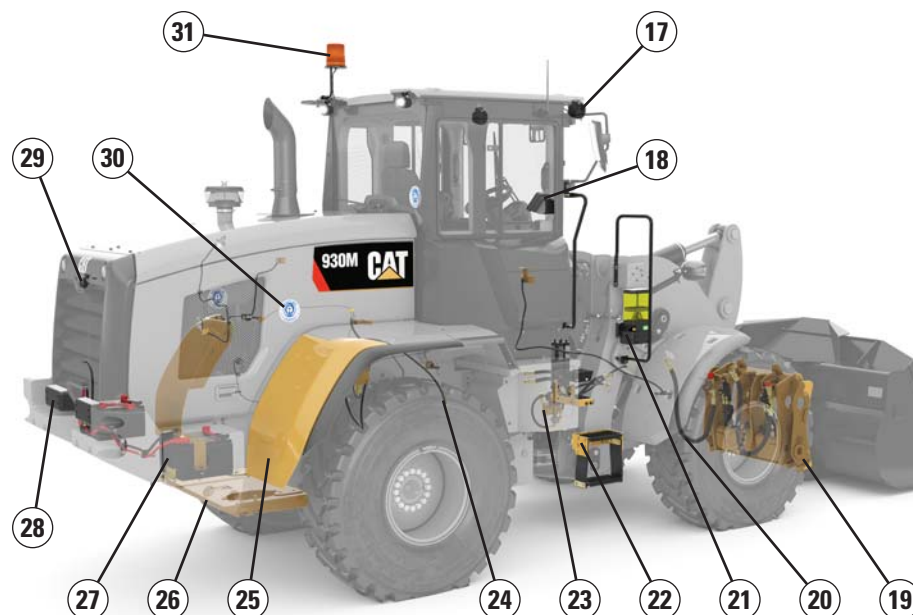

Other Options:

- 17) LED auxiliary lights
- 18) Secondary display*
- 19) Coupler: Fusion and ISO
- 20) Auxiliary hydraulics: 3rd and 4th
- 21) Autolube
- 22) Windshield washing platform
- 23) Ride control
- 24) Elevated breathers: axles and gear box
- 25) Fenders: extended and full coverage
- 26) Counterweights: heavy and Log/Agg
- 27) Cold start package
- 28) Rear object detection
- 29) Rearview camera*
- 30) Blue Angel certification
- 31) Beacon

*Standard equipment in Europe

Service

Schedule your downtime to maximize your up time.

Get up and running quickly with ground level, daily service access and optional engine compartment lighting. Three large service doors can be opened and closed in any order to give full access to filters and service points. Extended service intervals on hydraulic and power train filters reduce service time and maximize uptime. Additional service features include:



- **Product Link™ PRO standard** with three year subscription to VisionLink®.
- **Maintenance reminders** through secondary display at scheduled intervals.
- **Fit for Life Diesel Particulate Filter** that is designed to exceed the engine overhaul life.
- **Quick fuel filter service** with Caterpillar's exclusive electric fuel priming pump.
- **Jump start studs** as standard equipment.
- **Extended cleanouts** with single plane cooling system and wide spaced 6 fins per inch coolers as standard.
- **Integrated Autolube** (optional) with adjustable greasing frequency.

Customer Support

Unmatched service makes the difference.

Renowned Cat Dealer Support

Rely on your Cat dealer to help you every step of the way with new or used machine sales, rental or rebuild options to meet your business needs.

Maximize your machine uptime with unsurpassed worldwide parts availability, trained technicians and customer support agreements.

Let us earn your business. Experience an M Series Small Wheel Loader and join the Caterpillar family.



926M, 930M, 938M Wheel Loader Specifications

Engine

Cat C7.1 ACERT Power Mode	926M				930M				938M			
	Performance (HP+)		Standard		Performance (HP+)		Standard		Performance (HP+)		Standard	
	Range 1-4		Range 1-3*		Range 1-4		Range 1-3*		Range 1-4		Range 1-3*	
Maximum Rated Gross Power	1,800 rpm		1,600 rpm		1,800 rpm		1,600 rpm		1,800 rpm		1,600 rpm	
Maximum Engine Speed	1,800 rpm		1,600 rpm		1,800 rpm		1,600 rpm		1,800 rpm		1,600 rpm	
ISO 14396	114	153	109	146	122	164	119	160	140	188	129	173
ISO 14396 (DIN)	114	155	109	148	122	166	119	162	140	190	129	175
Rated Net Power	1,800 rpm		1,600 rpm		1,800 rpm		1,600 rpm		1,800 rpm		1,600 rpm	
SAE J1349 at Minimum Fan Speed	110	148	105	141	117	157	115	154	136	182	125	168
ISO 9249 (1977)/EEC 80/1269 at Minimum Fan Speed	111	149	106	142	119	160	116	156	137	184	126	169
ISO 9249 (DIN) at Minimum Fan Speed	111	151	106	144	119	162	116	158	137	186	126	171
Maximum Gross Torque	N-m	lbf-ft	N-m	lbf-ft	N-m	lbf-ft	N-m	lbf-ft	N-m	lbf-ft	N-m	lbf-ft
ISO 14396	721	531	721	531	804	592	804	592	879	648	879	648
Maximum Net Torque												
SAE J1349	694	511	694	511	768	566	768	566	843	621	843	621
ISO 9249 (1977)/EEC 80/1269	702	517	702	517	776	572	776	572	852	628	852	628
Displacement	427 in ³		7.01 L		427 in ³		7.01 L		427 in ³		7.01 L	
Bore	4 in		105 mm		4 in		105 mm		4 in		105 mm	
Stroke	5 in		135 mm		5 in		135 mm		5 in		135 mm	

* Range 4 power and torque is equal to Performance Mode with Caterpillar Power by Range technology.

- Net power ratings are tested at the reference conditions for the specified standard and denote power available at the flywheel when the engine is equipped with alternator, air cleaner, emission components and fan at specified speed.
- No derating required up to 3000 m (10,000 ft) altitude. Auto derate protects hydraulic and transmission systems.
- The Cat C7.1 ACERT engine meets Tier 4 Final/Stage IV off-highway emission standards.

Engine Torque

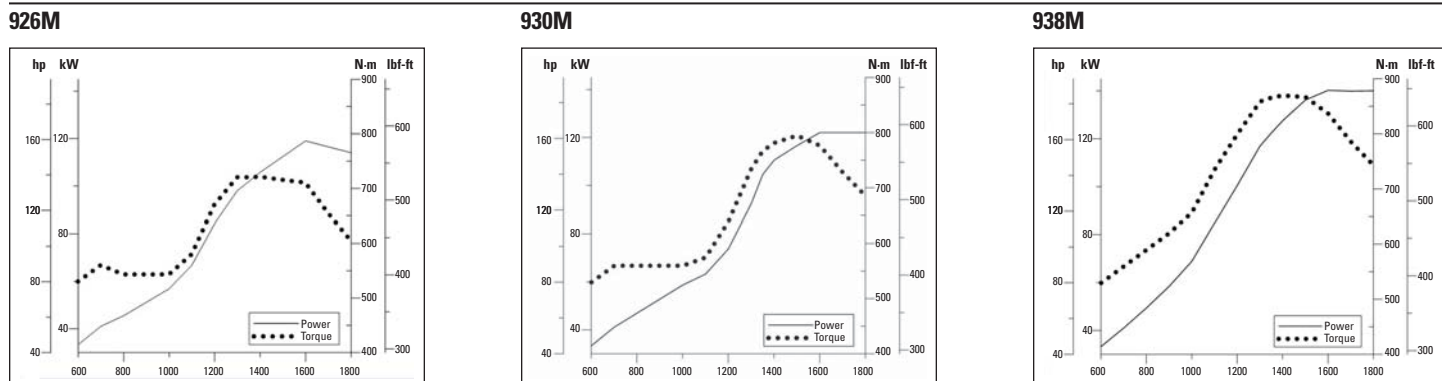

Cab



- ROPS: SAE J1040 MAY94, ISO 3471-1994.
- FOPS: SAE J/ISO 3449 APR98, Level II, ISO 3449 1992 Level II.
- The declared dynamic operator around pressures levels per ISO 6396:2008* while running in Performance Power Mode:
 - Standard cab: 68 ±3 dB(A) and Deluxe cab: 66 ±2 dB(A)

* The measurements were conducted with the cab doors and windows closed and at 70% of maximum engine cooling fan speed. The sound level may vary at different engine cooling fan speeds.

926M, 930M, 938M Wheel Loader Specifications

Loader Hydraulic System



- Implement system uses a dedicated load sensing variable displacement pump with dual double acting lift cylinders and a single double acting tilt cylinder.
- Flow values listed are for a machine running in Performance Power Mode (1,800 rpm).

* 3rd and 4th function flow is fully adjustable from 20% to 100% of maximum flow through the secondary display when equipped.

	926M		930M		938M	
Maximum Flow – Implement Pump	150 L/min	40 gal/min	190 L/min	50 gal/min	190 L/min	50 gal/min
3rd Function Maximum Flow*	150 L/min	40 gal/min	190 L/min	50 gal/min	190 L/min	50 gal/min
4th Function Maximum Flow*	150 L/min	40 gal/min	160 L/min	42 gal/min	160 L/min	42 gal/min
Maximum Working Pressure – Implement Pump	26 000 kPa	3,771 psi	25 000 kPa	3,626 psi	28 000 kPa	4,061 psi
Relief Pressure – Tilt Cylinder	28 000 kPa	4,061 psi	28 000 kPa	4,061 psi	30 000 kPa	4,351 psi
3rd and 4th Function Maximum Working Pressure	26 000 kPa	3,771 psi	25 000 kPa	3,626 psi	28 000 kPa	4,061 psi
3rd and 4th Function Relief Pressure	28 000 kPa	4,061 psi	28 000 kPa	4,061 psi	30 000 kPa	4,351 psi
Lift Cylinder: Double Acting						
Bore Diameter	110 mm	4.3 in	120 mm	4.7 in	120 mm	4.7 in
Rod Diameter	60 mm	2.4 in	65 mm	2.6 in	65 mm	2.6 in
Stroke	728 mm	28.7 in	728 mm	28.7 in	789 mm	31.1 in
Tilt Cylinder: Double Acting						
Bore Diameter	130 mm	5.1 in	150 mm	5.9 in	150 mm	5.9 in
Rod Diameter	70 mm	2.8 in	90 mm	3.5 in	90 mm	3.5 in
Stroke	555 mm	21.9 in	555 mm	21.9 in	555 mm	21.9 in
Cycle Times: Performance (HP+) at 1,800 rpm/ Standard Power Mode at 1,600 rpm						
Raise (Ground Level to Maximum Lift)	5.5/6.2 seconds		5.1/5.7 seconds		5.5/6.2 seconds	
Dump (at Maximum Lift Height)	1.5/1.7 seconds		1.5/1.7 seconds		1.5/1.7 seconds	
Float Down (Maximum Lift to Ground Level)	2.6/2.6 seconds		2.7/2.7 seconds		2.7/2.7 seconds	
Total Cycle Time	9.6/10.5 seconds		9.3/10.1 seconds		9.7/10.6 seconds	

Steering



- Steering system uses a dedicated load sensing variable displacement pump with dual double acting cylinders.
- Flow values listed are for a machine running in Performance Power Mode (1,800 rpm).

	926M		930M		938M	
Steering Cylinder: Double Acting						
Bore Diameter	70 mm	2.8 in	70 mm	2.8 in	80 mm	3.1 in
Rod Diameter	40 mm	1.6 in	40 mm	1.6 in	50 mm	2 in
Stroke	438 mm	17.2 in	438 mm	17.2 in	399 mm	15.7 in
Maximum Flow – Steering Pump	130 L/min	34 gal/min	130 L/min	34 gal/min	130 L/min	34 gal/min
Maximum Working Pressure – Steering Pump	24 130 kPa	3,500 psi	24 130 kPa	3,500 psi	24 130 kPa	3,500 psi
Maximum Steering Torque						
0° (Straight Machine)	50 375 N·m	37,155 lbf-ft	50 375 N·m	37,155 lbf-ft	57 630 N·m	42,506 lbf-ft
40° (Full Turn)	37 620 N·m	27,747 lbf-ft	37 620 N·m	27,747 lbf-ft	42 570 N·m	31,398 lbf-ft
Steering Cycle Times (Full Left to Full Right)						
Minimum RPM: Pump Flow Limited	2.8 seconds		2.8 seconds		3.1 seconds	
Maximum RPM: 90 rpm Steering Wheel Speed	2.4 seconds		2.4 seconds		2.3 seconds	

926M, 930M, 938M Wheel Loader Specifications

Transmission



* Creeper control allows maximum speed range adjustability from 1 km/h (0.6 mph) to 13 km/h (8 mph) in Range 1 through the secondary display when equipped. Factory default is 7 km/h (4.4 mph).

	926M		930M		938M	
Forward and Reverse						
Range 1*	1-13 km/h	0.6-8 mph	1-13 km/h	0.6-8 mph	1-13 km/h	0.6-8 mph
Range 2	13 km/h	8 mph	13 km/h	8 mph	13 km/h	8 mph
Range 3	27 km/h	17 mph	27 km/h	17 mph	27 km/h	17 mph
Range 4	40 km/h	25 mph	40 km/h	25 mph	40 km/h	25 mph

Service Refill Capacities

	926M		930M		938M	
Fuel Tank	195 L	51.5 gal	195 L	51.5 gal	195 L	51.5 gal
Diesel Exhaust Fluid (DEF) Tank	19 L	5.0 gal	19 L	5.0 gal	19 L	5.0 gal
Cooling System	30 L	7.9 gal	30 L	7.9 gal	32 L	8.5 gal
Engine Crankcase	20 L	5.3 gal	20 L	5.3 gal	20 L	5.3 gal
Transmission (Gear Box)	8.5 L	2.2 gal	8.5 L	2.2 gal	11 L	2.9 gal
Front Axles	21 L	5.5 gal	26 L	6.9 gal	35 L	9.2 gal
Rear Axles	21 L	5.5 gal	25 L	6.6 gal	35 L	9.2 gal
Hydraulic System (Including Tank)	160 L	42.3 gal	165 L	43.6 gal	170 L	44.9 gal
Hydraulic Tank	90 L	23.8 gal	90 L	23.8 gal	90 L	23.8 gal

Power Train

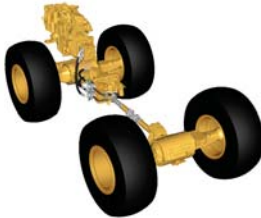

• Power train is governed by the Caterpillar exclusive Intelligent Power Management system to deliver peak performance and efficiency.

* Differential front locking axle can be engaged on the go at full torque to 10 km/h (6.2 mph) on the 926M/930M and up to 20 km/h (12.4 mph) on the 938M.

	926M	930M	938M
Front Axle	Fixed	Fixed	Fixed
Traction Aid (standard)	Locking differential	Locking differential	Locking differential
Rear Axle	Oscillating	Oscillating	Oscillating
Oscillation Angle by Tire Size			
17.5 R25	± 13.5 degrees	—	—
20.5 R25, 550/65, 600/65, 650/65	± 10.5 degrees	± 10.5 degrees	± 10.5 degrees
23.5 R25	—	—	± 7 degrees
Flexports, 750/65, 620/65, Skidder	± 7 degrees	± 7 degrees	± 7 degrees
Traction Aid (optional)	Limited slip differential	Limited slip differential	Limited slip differential
Brakes			
Service	Inboard wet disc	Inboard wet disc	Outboard wet disc
Park	Spring applied hydraulically released	Spring applied hydraulically released	Spring applied hydraulically released

926M, 930M, 938M Wheel Loader Specifications

Dimensions with Bucket

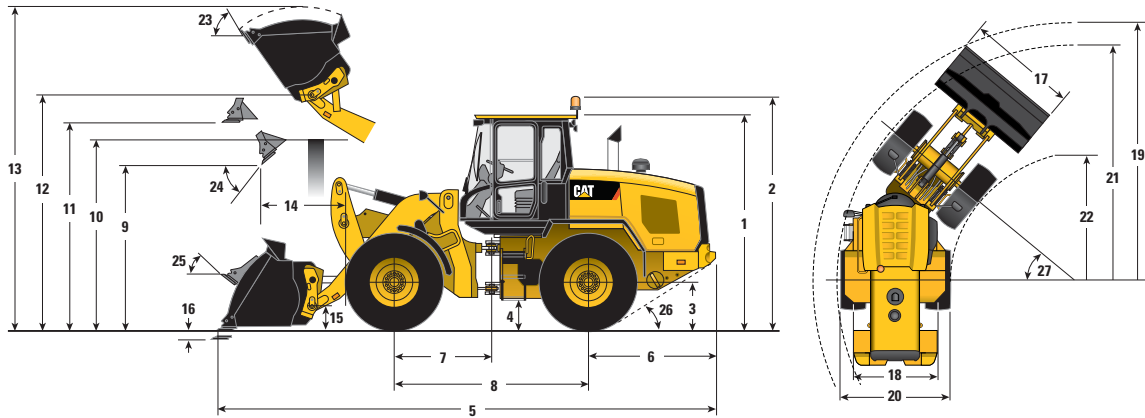

*Vary with bucket.

**Vary with tire.

Standard Lift

	926M		930M		938M	
** 1 Height: Ground to Cab	3340 mm	10'11"	3340 mm	10'11"	3340 mm	10'11"
** 2 Height: Ground to Beacon	3707 mm	12'1"	3707 mm	12'1"	3707 mm	12'1"
** 3 Height: Ground Axle Center	685 mm	2'2"	685 mm	2'2"	685 mm	2'2"
** 4 Height: Ground Clearance	397 mm	1'3"	397 mm	1'3"	386 mm	1'3"
* 5 Length: Overall	7451 mm	24'5"	7530 mm	24'8"	7656 mm	25'1"
6 Length: Rear Axle to Bumper	1986 mm	6'6"	1993 mm	6'6"	1968 mm	6'5"
7 Length: Hitch to Front Axle	1500 mm	4'11"	1500 mm	4'11"	1525 mm	5'0"
8 Length: Wheel Base	3000 mm	9'10"	3000 mm	9'10"	3050 mm	10'0"
* 9 Clearance: Bucket at 45°	2885 mm	9'5"	2828 mm	9'3"	2834 mm	9'3"
** 10 Clearance: Load over Height	3330 mm	10'11"	3331 mm	10'11"	3354 mm	11'0"
** 11 Clearance: Level Bucket	3580 mm	11'8"	3580 mm	11'8"	3641 mm	11'11"
** 12 Height: Bucket Pin	3907 mm	12'9"	3907 mm	12'9"	3969 mm	13'0"
** 13 Height: Overall	5076 mm	16'7"	5147 mm	16'10"	5273 mm	17'3"
* 14 Reach: Bucket at 45°	1024 mm	3'4"	1064 mm	3'5"	1146 mm	3'9"
15 Carry Height: Bucket Pin	460 mm	1'6"	460 mm	1'6"	473 mm	1'6"
** 16 Dig Depth	100 mm	3.9"	100 mm	3.9"	101 mm	3.9"
17 Width: Bucket	2550 mm	8'4"	2550 mm	8'4"	2750 mm	9'0"
18 Width: Tread Center	1930 mm	6'3"	1930 mm	6'3"	2083 mm	6'10"
19 Turning Radius: Over Bucket	5924 mm	19'5"	5946 mm	19'6"	6134 mm	20'1"
20 Width: Over Tires	2540 mm	8'4"	2540 mm	8'4"	2693 mm	8'10"
21 Turning Radius: Outside of Tires	5402 mm	17'8"	5402 mm	17'8"	5546 mm	18'2"
22 Turning Radius: Inside of Tires	2851 mm	9'4"	2851 mm	9'4"	2843 mm	9'3"
23 Rack Angle at Full Lift	54°		54°		54°	
24 Dump Angle at Full Lift	50°		49°		49°	
25 Rack Angle at Carry	45°		45°		46°	
26 Departure Angle	33°		33°		33°	
27 Articulation Angle	40°		40°		40°	

Unless otherwise noted, all Standard Lift dimensions and specifications listed are for a machine configured with the following:

Optional Equipment	Full Fluids, 80 kg (176 lb) Operator, Secondary Steering, Ride Control, Crankcase, Power Train and Driveshaft Guards, Bucket with Bolt-on Cutting Edge					
Tires – Michelin	20.5R25 (L-3) XHA2		20.5R25 (L-3) XHA2		20.5R25 (L-3) XHA2	
Pressure in Front Tires	4.14 bar	60 psi	4.14 bar	60 psi	4.48 bar	65 psi
Pressure in Rear Tires	2.76 bar	40 psi	2.76 bar	40 psi	2.76 bar	40 psi

Counterweight Group

Heavy

Heavy

Heavy

926M, 930M, 938M Wheel Loader Specifications

Dimensions with Bucket

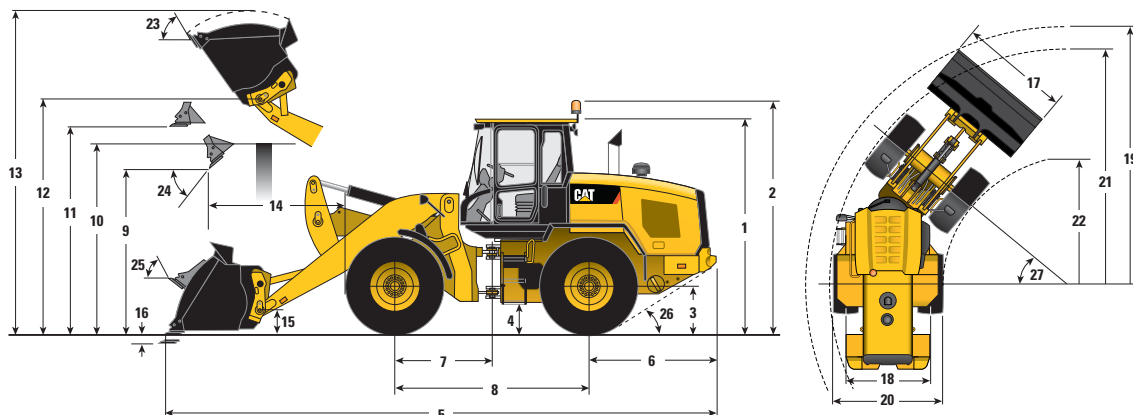

*Vary with bucket.

**Vary with tire.

	High Lift					
	926M		930M		938M	
** 1 Height: Ground to Cab	3340 mm	10'11"	3340 mm	10'11"	3340 mm	10'11"
** 2 Height: Ground to Beacon	3707 mm	12'1"	3707 mm	12'1"	3707 mm	12'1"
** 3 Height: Ground Axle Center	685 mm	2'2"	685 mm	2'2"	685 mm	2'2"
** 4 Height: Ground Clearance	397 mm	1'3"	397 mm	1'3"	386 mm	1'3"
* 5 Length: Overall	8093 mm	26'6"	8324 mm	27'3"	8397 mm	27'6"
6 Length: Rear Axle to Bumper	1986 mm	6'6"	1993 mm	6'6"	1968 mm	6'5"
7 Length: Hitch to Front Axle	1500 mm	4'11"	1500 mm	4'11"	1525 mm	5'0"
8 Length: Wheel Base	3000 mm	9'10"	3000 mm	9'10"	3050 mm	10'0"
* 9 Clearance: Bucket at 45°	3378 mm	11'0"	3421 mm	11'2"	3415 mm	11'2"
** 10 Clearance: Load over Height	3550 mm	11'7"	3540 mm	11'7"	3561 mm	11'8"
** 11 Clearance: Level Bucket	4073 mm	13'4"	4173 mm	13'8"	4222 mm	13'10"
** 12 Height: Bucket Pin	4400 mm	14'5"	4500 mm	14'9"	4550 mm	14'11"
** 13 Height: Overall	5569 mm	18'3"	5740 mm	18'9"	5853 mm	19'2"
* 14 Reach: Bucket at 45°	1261 mm	4'1"	1385 mm	4'6"	1413 mm	4'7"
15 Carry Height: Bucket Pin	644 mm	2'1"	684 mm	2'2"	682 mm	2'2"
** 16 Dig Depth	135 mm	5.3"	135 mm	5.3"	135 mm	5.3"
17 Width: Bucket	2550 mm	8'4"	2550 mm	8'4"	2750 mm	9'0"
18 Width: Tread Center	1930 mm	6'3"	1930 mm	6'3"	2083 mm	6'10"
19 Turning Radius: Over Bucket	6234 mm	20'5"	6328 mm	20'9"	6490 mm	21'3"
20 Width: Over Tires	2540 mm	8'4"	2540 mm	8'4"	2693 mm	8'10"
21 Turning Radius: Outside of Tires	5402 mm	17'8"	5402 mm	17'8"	5546 mm	18'2"
22 Turning Radius: Inside of Tires	2851 mm	9'4"	2851 mm	9'4"	2843 mm	9'3"
23 Rack Angle at Full Lift	51°		53°		53°	
24 Dump Angle at Full Lift	49°		48°		47°	
25 Rack Angle at Carry	49°		50°		50°	
26 Departure Angle	33°		33°		33°	
27 Articulation Angle	40°		40°		40°	

Unless otherwise noted, all High Lift dimensions and specifications listed are for a machine configured with the following:

Optional Equipment	Full Fluids, 80 kg (176 lb) Operator, Secondary Steering, Ride Control, Crankcase, Power Train and Driveshaft Guards, Bucket with Bolt-on Cutting Edge					
Tires – Michelin	20.5R25 (L-3) XHA2		20.5R25 (L-3) XHA2		20.5R25 (L-3) XHA2	
Pressure in Front Tires	4.14 bar	60 psi	4.14 bar	60 psi	4.48 bar	65 psi
Pressure in Rear Tires	2.76 bar	40 psi	2.76 bar	40 psi	2.76 bar	40 psi

Counterweight Group



Heavy

Heavy

Standard

Bucket Specifications

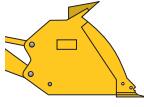
926M Operating Specifications with Buckets

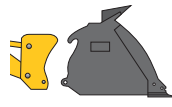
		General Purpose									High Lift
		 Pin On			 Fusion			 ISO 23727			
Capacity – rated	m ³	1.9	2.1	2.3	1.9	2.1	2.3	2.1	2.3	–	
	yd ³	2.5	2.7	3.0	2.5	2.7	3.0	2.7	3.0	–	
Capacity – rated at 110% fill factor	m ³	2.1	2.3	2.5	2.1	2.3	2.5	2.3	2.5	–	
	yd ³	2.7	3.0	3.3	2.7	3.0	3.3	3.0	3.3	–	
17 Width: bucket	mm	2550	2550	2550	2550	2550	2550	2550	2550	–	
	ft/in	8'4"	8'4"	8'4"	8'4"	8'4"	8'4"	8'4"	8'4"	–	
Nominal material density, 110% fill factor	kg/m ³	1889	1696	1529	1800	1612	1457	1530	1383	–	
	lb/yd ³	3,223	2,879	2,584	3,072	2,736	2,462	2,598	2,338	–	
9 Clearance: full lift, 45° dump	mm	2912	2855	2807	2885	2828	2779	2727	2677	+493	
	ft/in	9'6"	9'4"	9'2"	9'5"	9'3"	9'1"	8'11"	8'9"	+1'7"	
14 Reach: full lift, 45° dump	mm	992	1033	1070	1024	1064	1102	1190	1227	+237	
	ft/in	3'3"	3'4"	3'6"	3'4"	3'5"	3'7"	3'10"	4'0"	+9"	
Reach: 2130 mm (7'0") clearance, 45° dump	mm	1547	1560	1573	1566	1578	1590	1649	1657	+572	
	ft/in	5'0"	5'1"	5'1"	5'1"	5'2"	5'2"	5'4"	5'5"	+1'10"	
Reach: level arm, level bucket	mm	2278	2350	2413	2320	2392	2455	2553	2616	+523	
	ft/in	7'5"	7'8"	7'11"	7'7"	7'10"	8'0"	8'4"	8'6"	+1'8"	
16 Dig depth	mm	100	100	100	100	100	100	94	94	+35	
	in	3.9"	3.9"	3.9"	3.9"	3.9"	3.9"	3.7"	3.7"	+1.4"	
5 Length: overall	mm	7409	7481	7544	7451	7523	7586	7679	7742	+642	
	ft/in	24'3"	24'6"	24'9"	24'5"	24'8"	24'10"	25'2"	25'4"	+2'1"	
13 Height: overall	mm	5052	5122	5180	5076	5147	5205	5255	5313	+493	
	ft/in	16'6"	16'9"	16'11"	16'7"	16'10"	17'0"	17'2"	17'5"	+1'7"	
19 Turning radius: over bucket	mm	5912	5933	5951	5924	5946	5964	5975	5995	+311	
	ft/in	19'4"	19'5"	19'6"	19'5"	19'6"	19'6"	19'7"	19'8"	+1'0"	
Tipping load – straight, ISO 14397-1*	kg	9179	9115	9008	8786	8701	8621	8268	8190	–2171	
	lb	20,235	20,094	19,859	19,370	19,182	19,005	18,227	18,056	–4,786	
Tipping load – straight, rigid tire**	kg	9561	9494	9384	9152	9064	8980	8612	8531	–2262	
	lb	21,078	20,931	20,687	20,177	19,982	19,797	18,987	18,808	–4,985	
Tipping load – full turn, ISO 14397-1*	kg	7894	7836	7737	7524	7445	7371	7070	6999	–1911	
	lb	17,403	17,276	17,057	16,587	16,414	16,251	15,587	15,429	–4,213	
Tipping load – full turn, rigid tire**	kg	8398	8336	8231	8004	7921	7842	7522	7445	–2033	
	lb	18,514	18,378	18,145	17,646	17,461	17,288	16,582	16,414	–4,482	
Breakout force	kg	10 685	9966	9388	10 229	9552	9023	8235	7822	–494	
	lb	23,557	21,972	20,697	22,550	21,059	19,893	18,154	17,245	–1,089	
Operating weight	kg	12 696	12 715	12 778	13 050	13 094	13 132	13 060	13 098	+278	
	lb	27,989	28,031	28,171	28,770	28,867	28,950	28,792	28,876	+613	

*Full compliance to ISO 14397-1 (2007) Sections 1 thru 6, which requires 2% verification between calculation and testing.

**Compliance to ISO 14397-1 (2007) Sections 1 thru 5.

Bucket Specifications

926M Operating Specifications with Buckets

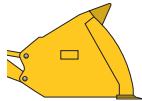
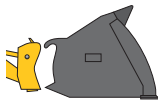
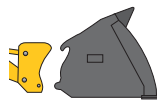

		Light Material									High Lift
		 Pin On			 Fusion			 ISO 23727			
Capacity – rated	m ³	3.1	3.5	3.8	3.1	3.5	3.8	3.5	4.1	–	
	yd ³	4.1	4.6	5.0	4.0	4.6	5.0	4.6	5.4	–	
Capacity – rated at 110% fill factor	m ³	3.4	3.9	4.2	3.4	3.9	4.2	3.9	4.5	–	
	yd ³	4.5	5.0	5.5	4.4	5.0	5.5	5.0	5.9	–	
17 Width: bucket	mm	2750	2750	2750	2750	2750	2750	2750	2750	–	
	ft/in	9'0"	9'0"	9'0"	9'0"	9'0"	9'0"	9'0"	9'0"	–	
Nominal material density, 110% fill factor	kg/m ³	1094	951	860	1058	904	817	864	709	–	
	lb/yd ³	1,828	1,614	1,441	1,785	1,534	1,369	1,466	1,194	–	
9 Clearance: full lift, 45° dump	mm	2703	2631	2573	2672	2600	2543	2527	2407	+505	
	ft/in	8'10"	8'7"	8'5"	8'9"	8'6"	8'4"	8'3"	7'10"	+1'7"	
14 Reach: full lift, 45° dump	mm	1066	1138	1196	1094	1167	1225	1206	1326	+256	
	ft/in	3'5"	3'8"	3'11"	3'7"	3'9"	4'0"	3'11"	4'4"	+10"	
Reach: 2130 mm (7'0") clearance, 45° dump	mm	1509	1538	1559	1521	1549	1569	1538	1571	+592	
	ft/in	4'11"	5'0"	5'1"	4'11"	5'0"	5'1"	5'0"	5'1"	+1'11"	
Reach: level arm, level bucket	mm	2500	2603	2685	2543	2645	2726	2724	2894	+523	
	ft/in	8'2"	8'6"	8'9"	8'4"	8'8"	8'11"	8'11"	9'5"	+1'8"	
16 Dig depth	mm	100	100	100	100	100	100	125	125	+35	
	in	3.9"	3.9"	3.9"	3.9"	3.9"	3.9"	4.9"	4.9"	+1.4"	
5 Length: overall	mm	7632	7734	7816	7674	7776	7858	7875	8045	+642	
	ft/in	25'0"	25'4"	25'7"	25'2"	25'6"	25'9"	25'10"	26'4"	+2'1"	
13 Height: overall	mm	5179	5284	5356	5204	5309	5383	5385	5552	+493	
	ft/in	16'11"	17'4"	17'6"	17'0"	17'5"	17'7"	17'8"	18'2"	+1'7"	
19 Turning radius: over bucket	mm	6068	6099	6124	6082	6112	6138	6126	6183	+313	
	ft/in	19'10"	20'0"	20'1"	19'11"	20'0"	20'1"	20'1"	20'3"	+1'0"	
Tipping load – straight, ISO 14397-1*	kg	8719	8566	8424	8359	8181	8042	7824	7543	–2100	
	lb	19,221	18,884	18,570	18,428	18,035	17,730	17,248	16,628	–4,630	
Tipping load – straight, rigid tire**	kg	9082	8923	8775	8707	8522	8378	8150	7857	–2188	
	lb	20,022	19,671	19,344	19,196	18,786	18,469	17,967	17,321	–4,823	
Tipping load – full turn, ISO 14397-1*	kg	7463	7321	7190	7124	6957	6830	6652	6390	–1851	
	lb	16,452	16,139	15,852	15,706	15,337	15,058	14,664	14,088	–4,080	
Tipping load – full turn, rigid tire**	kg	7939	7788	7649	7579	7401	7266	7076	6798	–1969	
	lb	17,503	17,169	16,863	16,708	16,316	16,019	15,600	14,987	–4,341	
Breakout force	kg	8616	7890	7768	8301	7609	7490	7094	5961	–423	
	lb	18,995	17,393	17,124	18,301	16,774	16,513	15,638	13,141	–932	
Operating weight	kg	13 006	13 092	13 158	13 337	13 455	13 521	13 375	13 538	+278	
	lb	28,674	28,862	29,008	29,403	29,663	29,808	29,487	29,847	+613	

*Full compliance to ISO 14397-1 (2007) Sections 1 thru 6, which requires 2% verification between calculation and testing.

**Compliance to ISO 14397-1 (2007) Sections 1 thru 5.

Bucket Specifications

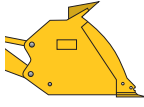
930M Operating Specifications with Buckets

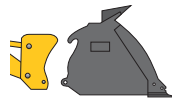
		General Purpose									High Lift
		 Pin On			 Fusion			 ISO 23727			
Capacity – rated	m ³	2.1	2.3	2.5	2.1	2.3	2.5	2.1	2.3	–	
	yd ³	2.7	3.0	3.3	2.7	3.0	3.3	2.7	3.0	–	
Capacity – rated at 110% fill factor	m ³	2.3	2.5	2.8	2.3	2.5	2.8	2.3	2.5	–	
	yd ³	3.0	3.3	3.6	3.0	3.3	3.6	3.0	3.3	–	
17 Width: bucket	mm	2550	2550	2550	2550	2550	2550	2550	2550	–	
	ft/in	8'4"	8'4"	8'4"	8'4"	8'4"	8'4"	8'4"	8'4"	–	
Nominal material density, 110% fill factor	kg/m ³	1921	1733	1571	1833	1658	1505	1742	1575	–	
	lb/yd ³	3,260	2,929	2,645	3,112	2,803	2,535	2,957	2,662	–	
9 Clearance: full lift, 45° dump	mm	2855	2807	2761	2828	2779	2733	2727	2677	+593	
	ft/in	9'4"	9'2"	9'0"	9'3"	9'1"	8'11"	8'11"	8'9"	+1'11"	
14 Reach: full lift, 45° dump	mm	1033	1070	1109	1064	1102	1140	1190	1227	+320	
	ft/in	3'4"	3'6"	3'7"	3'5"	3'7"	3'8"	3'10"	4'0"	+13"	
Reach: 2130 mm (7'0") clearance, 45° dump	mm	1560	1573	1587	1578	1590	1603	1649	1657	+717	
	ft/in	5'1"	5'1"	5'2"	5'2"	5'2"	5'3"	5'4"	5'5"	+2'4"	
Reach: level arm, level bucket	mm	2350	2413	2475	2392	2455	2517	2553	2616	+653	
	ft/in	7'8"	7'11"	8'1"	7'10"	8'0"	8'3"	8'4"	8'6"	+2'1"	
16 Dig depth	mm	100	100	100	100	100	100	94	94	+35	
	in	3.9"	3.9"	3.9"	3.9"	3.9"	3.9"	3.7"	3.7"	+1.4"	
5 Length: overall	mm	7488	7551	7613	7530	7593	7655	7686	7749	+794	
	ft/in	24'6"	24'9"	24'11"	24'8"	24'10"	25'1"	25'2"	25'5"	+2'7"	
13 Height: overall	mm	5122	5180	5239	5147	5205	5264	5255	5313	+593	
	ft/in	16'9"	16'11"	17'2"	16'10"	17'0"	17'3"	17'2"	17'5"	+1'11"	
19 Turning radius: over bucket	mm	5933	5951	5970	5946	5964	5983	5975	5995	+384	
	ft/in	19'5"	19'6"	19'7"	19'6"	19'6"	19'7"	19'7"	19'8"	+1'3"	
Tipping load – straight, ISO 14397-1*	kg	10 370	10 258	10 119	9941	9855	9734	9450	9367	–2823	
	lb	22,862	22,615	22,309	21,915	21,726	21,460	20,834	20,651	–6,222	
Tipping load – straight, rigid tire**	kg	10 802	10 685	10 541	10 355	10 265	10 140	9844	9758	–2940	
	lb	23,814	23,557	23,239	22,828	22,631	22,354	21,702	21,511	–6,482	
Tipping load – full turn, ISO 14397-1*	kg	8873	8769	8639	8469	8390	8278	8047	7971	–2471	
	lb	19,561	19,332	19,045	18,670	18,497	18,249	17,740	17,572	–5,448	
Tipping load – full turn, rigid tire**	kg	9439	9329	9190	9009	8926	8806	8560	8480	–2629	
	lb	20,810	20,566	20,260	19,862	19,678	19,414	18,872	18,694	–5,795	
Breakout force	kg	12 891	12 158	11 488	12 371	11 698	11 080	10 707	10 182	–299	
	lb	28,419	26,803	25,326	27,274	25,790	24,427	23,604	22,448	–658	
Operating weight	kg	13 627	13 691	13 789	14 007	14 044	14 127	13 973	14 011	+232	
	lb	30,042	30,182	30,400	30,879	30,962	31,144	30,804	30,888	+511	

*Full compliance to ISO 14397-1 (2007) Sections 1 thru 6, which requires 2% verification between calculation and testing.

**Compliance to ISO 14397-1 (2007) Sections 1 thru 5.

Bucket Specifications

930M Operating Specifications with Buckets

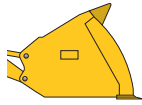
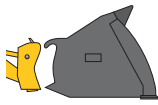
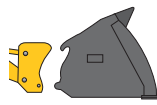

		Light Material									High Lift
		 Pin On			 Fusion			 ISO 23727			
Capacity – rated	m ³	3.5	3.8	4.2	3.5	3.8	4.2	3.5	5.0	–	
	yd ³	4.6	5.0	5.5	4.6	5.0	5.5	4.6	6.5	–	
Capacity – rated at 110% fill factor	m ³	3.9	4.2	4.6	3.9	4.2	4.6	3.9	5.5	–	
	yd ³	5.0	5.5	6.0	5.0	5.5	6.0	5.0	7.2	–	
17 Width: bucket	mm	2750	2750	2750	2750	2750	2750	2750	2750	–	
	ft/in	9'0"	9'0"	9'0"	9'0"	9'0"	9'0"	9'0"	9'0"	–	
Nominal material density, 110% fill factor	kg/m ³	1083	981	874	1034	936	834	989	665	–	
	lb/yd ³	1,838	1,643	1,484	1,755	1,568	1,416	1,678	1,120	–	
9 Clearance: full lift, 45° dump	mm	2631	2573	2510	2600	2543	2480	2527	2357	+607	
	ft/in	8'7"	8'5"	8'2"	8'6"	8'4"	8'1"	8'3"	7'8"	+1'11"	
14 Reach: full lift, 45° dump	mm	1138	1196	1259	1167	1225	1287	1206	1377	+342	
	ft/in	3'8"	3'11"	4'1"	3'9"	4'0"	4'2"	3'11"	4'6"	+13"	
Reach: 2130 mm (7'0") clearance, 45° dump	mm	1538	1559	1579	1549	1569	1588	1538	1581	+746	
	ft/in	5'0"	5'1"	5'2"	5'0"	5'1"	5'2"	5'0"	5'2"	+2'5"	
Reach: level arm, level bucket	mm	2603	2685	2773	2645	2726	2815	2724	2966	+653	
	ft/in	8'6"	8'9"	9'1"	8'8"	8'11"	9'2"	8'11"	9'8"	+2'1"	
16 Dig depth	mm	100	100	100	100	100	100	125	125	+35	
	in	3.9"	3.9"	3.9"	3.9"	3.9"	3.9"	4.9"	4.9"	+1.4"	
5 Length: overall	mm	7741	7823	7911	7783	7865	7953	7882	8124	+794	
	ft/in	25'4"	25'7"	25'11"	25'6"	25'9"	26'1"	25'10"	26'7"	+2'7"	
13 Height: overall	mm	5284	5356	5445	5309	5383	5471	5385	5840	+593	
	ft/in	17'4"	17'6"	17'10"	17'5"	17'7"	17'11"	17'8"	19'1"	+1'11"	
19 Turning radius: over bucket	mm	6099	6124	6152	6112	6138	6166	6126	6208	+386	
	ft/in	20'0"	20'1"	20'2"	20'0"	20'1"	20'2"	20'1"	20'4"	+1'3"	
Tipping load – straight, ISO 14397-1*	kg	9796	9643	9512	9395	9247	9118	8988	8667	–2712	
	lb	21,596	21,260	20,969	20,713	20,386	20,102	19,814	19,107	–5,978	
Tipping load – straight, rigid tire**	kg	10 204	10 045	9908	9787	9632	9498	9362	9028	–2825	
	lb	22,496	22,145	21,843	21,576	21,235	20,940	20,639	19,904	–6,227	
Tipping load – full turn, ISO 14397-1*	kg	8337	8198	8077	7960	7825	7707	7613	7313	–2377	
	lb	18,378	18,072	17,805	17,549	17,251	16,990	16,783	16,121	–5,241	
Tipping load – full turn, rigid tire**	kg	8869	8721	8592	8468	8325	8199	8099	7780	–2529	
	lb	19,552	19,226	18,942	18,669	18,352	18,075	17,854	17,150	–5,575	
Breakout force	kg	10 278	10 140	9024	9926	9792	8740	9293	7810	–250	
	lb	22,658	22,354	19,895	21,883	21,588	19,267	20,488	17,218	–551	
Operating weight	kg	14 004	14 070	14 134	14 367	14 433	14 497	14 288	14 510	+232	
	lb	30,874	31,019	31,160	31,674	31,819	31,960	31,498	31,990	+511	

*Full compliance to ISO 14397-1 (2007) Sections 1 thru 6, which requires 2% verification between calculation and testing.

**Compliance to ISO 14397-1 (2007) Sections 1 thru 5.

Bucket Specifications

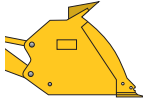
938M Operating Specifications with Buckets

		General Purpose									High Lift
		 Pin On			 Fusion			 ISO 23727			
Capacity – rated	m ³	2.5	2.7	2.9	2.5	2.7	2.9	2.5	2.7	–	
	yd ³	3.3	3.5	3.8	3.3	3.5	3.8	3.3	3.5	–	
Capacity – rated at 110% fill factor	m ³	2.8	3.0	3.2	2.8	3.0	3.2	2.8	3.0	–	
	yd ³	3.6	3.9	4.2	3.6	3.9	4.2	3.6	3.9	–	
17 Width: bucket	mm	2750	2750	2750	2750	2750	2750	2750	2750	–	
	ft/in	9'0"	9'0"	9'0"	9'0"	9'0"	9'0"	9'0"	9'0"	–	
Nominal material density, 110% fill factor	kg/m ³	1912	1755	1622	1823	1673	1546	1751	1605	–	
	lb/yd ³	3,220	2,947	2,716	3,070	2,809	2,589	2,949	2,695	–	
9 Clearance: full lift, 45° dump	mm	2869	2822	2786	2834	2787	2751	2739	2691	+581	
	ft/in	9'4"	9'3"	9'1"	9'3"	9'1"	9'0"	8'11"	8'9"	+1'10"	
14 Reach: full lift, 45° dump	mm	1108	1146	1178	1146	1185	1216	1264	1302	+267	
	ft/in	3'7"	3'9"	3'10"	3'9"	3'10"	3'11"	4'1"	4'3"	+11"	
Reach: 2130 mm (7'0") clearance, 45° dump	mm	1637	1652	1664	1658	1672	1684	1725	1736	+666	
	ft/in	5'4"	5'5"	5'5"	5'5"	5'5"	5'6"	5'7"	5'8"	+2'2"	
Reach: level arm, level bucket	mm	2452	2514	2563	2504	2566	2615	2655	2717	+607	
	ft/in	8'0"	8'2"	8'4"	8'2"	8'5"	8'6"	8'8"	8'10"	+1'11"	
16 Dig depth	mm	100	100	100	101	101	101	94	94	+35	
	in	3.9"	3.9"	3.9"	4"	4"	4"	3.7"	3.7"	+1.4"	
5 Length: overall	mm	7604	7666	7715	7656	7718	7767	7802	7864	+740	
	ft/in	24'11"	25'1"	25'3"	25'1"	25'3"	25'5"	25'7"	25'9"	+2'5"	
13 Height: overall	mm	5242	5301	5348	5273	5332	5379	5375	5434	+581	
	ft/in	17'2"	17'4"	17'6"	17'3"	17'5"	17'7"	17'7"	17'9"	+1'10"	
19 Turning radius: over bucket	mm	6117	6136	6150	6134	6152	6167	6160	6180	+357	
	ft/in	20'0"	20'1"	20'2"	20'1"	20'2"	20'2"	20'2"	20'3"	+1'2"	
Tipping load – straight, ISO 14397-1*	kg	12 344	12 245	12 161	11 820	11 721	11 641	11 349	11 245	–3607***	
	lb	27,214	26,995	26,810	26,057	25,840	25,663	25,019	24,791	–7,952	
Tipping load – straight, rigid tire**	kg	12 859	12 755	12 668	12 312	12 210	12 126	11 822	11 714	–3757***	
	lb	28,348	28,120	27,928	27,143	26,917	26,732	26,062	25,824	–8,284	
Tipping load – full turn, ISO 14397-1*	kg	10 517	10 426	10 350	10 028	9938	9864	9632	9536	–3125***	
	lb	23,186	22,986	22,817	22,107	21,909	21,747	21,234	21,024	–6,890	
Tipping load – full turn, rigid tire**	kg	11 189	11 092	11 011	10 668	10 572	10 494	10 246	10 145	–3325***	
	lb	24,666	24,453	24,274	23,518	23,307	23,135	22,589	22,366	–7,330	
Breakout force	kg	13 813	13 082	12 552	13 170	12 498	12 009	11 583	11 039	–502	
	lb	30,451	28,841	27,673	29,035	27,553	26,474	25,537	24,336	–1,107	
Operating weight	kg	16 001	16 046	16 082	16 427	16 472	16 508	16 316	16 367	–102***	
	lb	35,276	35,374	35,455	36,216	36,313	36,393	35,970	36,083	–224	



*Full compliance to ISO 14397-1 (2007) Sections 1 thru 6, which requires 2% verification between calculation and testing.

**Compliance to ISO 14397-1 (2007) Sections 1 thru 5.

***938M High Lift is configured with standard counterweight.

Bucket Specifications

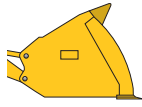
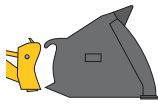
938M Operating Specifications with Buckets

		Light Material								
		 Pin On			 Fusion			 ISO 23727		
Capacity – rated	m ³	3.8	4.2	5.0	3.8	4.2	5.0	4.2	5.0	–
	yd ³	5.0	5.5	6.5	5.0	5.5	6.5	5.4	6.5	–
Capacity – rated at 110% fill factor	m ³	4.2	4.6	5.5	4.2	4.6	5.5	4.5	5.5	–
	yd ³	5.5	6.0	7.2	5.5	6.0	7.2	5.9	7.2	–
17 Width: bucket	mm	2750	2750	2750	2750	2750	2750	2750	2750	–
	ft/in	9'0"	9'0"	9'0"	9'0"	9'0"	9'0"	9'0"	9'0"	–
Nominal material density, 110% fill factor	kg/m ³	1198	1068	897	1141	1019	853	1005	822	–
	lb/yd ³	2,007	1,813	1,510	1,912	1,730	1,437	1,693	1,384	–
9 Clearance: full lift, 45° dump	mm	2633	2571	2571	2596	2534	2534	2468	2417	+598
	ft/in	8'7"	8'5"	8'5"	8'6"	8'3"	8'3"	8'1"	7'11"	+1'11"
14 Reach: full lift, 45° dump	mm	1232	1294	1294	1268	1331	1331	1362	1413	+292
	ft/in	4'0"	4'2"	4'2"	4'1"	4'4"	4'4"	4'5"	4'7"	+11"
Reach: 2130 mm (7'0") clearance, 45° dump	mm	1631	1654	1654	1644	1666	1666	1650	1664	+695
	ft/in	5'4"	5'5"	5'5"	5'4"	5'5"	5'5"	5'4"	5'5"	+2'3"
Reach: level arm, level bucket	mm	2723	2812	2812	2775	2864	2864	2932	3004	+607
	ft/in	8'11"	9'2"	9'2"	9'1"	9'4"	9'4"	9'7"	9'10"	+1'11"
16 Dig depth	mm	100	100	100	101	101	101	125	125	+35
	in	3.9"	3.9"	3.9"	4"	4"	4"	4.9"	4.9"	+1.4"
5 Length: overall	mm	7875	7964	7964	7928	8016	8016	8105	8177	+740
	ft/in	25'10"	26'1"	26'1"	26'0"	26'3"	26'3"	26'7"	26'9"	+2'5"
13 Height: overall	mm	5418	5507	5786	5450	5539	5820	5614	5902	+581
	ft/in	17'9"	18'0"	18'11"	17'10"	18'2"	19'1"	18'5"	19'4"	+1'10"
19 Turning radius: over bucket	mm	6198	6227	6227	6216	6244	6244	6258	6282	+365
	ft/in	20'4"	20'5"	20'5"	20'4"	20'5"	20'5"	20'6"	20'7"	+1'2"
Tipping load – straight, ISO 14397-1*	kg	11 794	11 637	11 636	11 289	11 151	11 120	10 728	10 713	–3443***
	lb	26,002	25,654	25,653	24,887	24,582	24,515	23,652	23,617	–7,591
Tipping load – straight, rigid tire**	kg	12 286	12 122	12 121	11 759	11 615	11 583	11 175	11 159	–3586***
	lb	27,085	26,723	26,722	25,924	25,607	25,537	24,637	24,601	–7,907
Tipping load – full turn, ISO 14397-1*	kg	10 015	9870	9866	9542	9416	9383	9059	9040	–2986***
	lb	22,078	21,758	21,750	21,037	20,759	20,686	19,972	19,930	–6,583
Tipping load – full turn, rigid tire**	kg	10 654	10 499	10 495	10 152	10 017	9982	9638	9617	–3177***
	lb	23,487	23,147	23,138	22,380	22,084	22,007	21,247	21,202	–7,004
Breakout force	kg	11 603	10 331	10 292	11 122	9942	9888	9023	8977	–437
	lb	25,581	22,775	22,690	24,519	21,918	21,798	19,891	19,791	–963
Operating weight	kg	16 270	16 347	16 394	16 694	16 757	16 835	16 653	16 713	–102***
	lb	35,870	36,039	36,143	36,802	36,943	37,114	36,713	36,845	–224

*Full compliance to ISO 14397-1 (2007) Sections 1 thru 6, which requires 2% verification between calculation and testing.

**Compliance to ISO 14397-1 (2007) Sections 1 thru 5.

***938M High Lift is configured with standard counterweight.

Bucket Selection Tables

General Purpose Bucket Selection – Standard Lift

Material Type		Fill Factor %													Tip Load Full Turn*		
		105%	105%	110%	105%	105%	110%	105%	105%	110%	115%	110%	110%	115%			110%
926M	Pin On	m ³	Counter-weight	kg/m ³	1400	1475	1550	1625	1700	1775	1850	1925	2000	2075	2150	kg	lb
		yd ³	lb/yd ³	(2,359)	(2,485)	(2,612)	(2,738)	(2,865)	(2,991)	(3,117)	(3,244)	(3,370)	(3,496)	(3,623)			
926M	Pin On	1.9	Log/Agg								115%	110%	105%	100%		8318	(18,338)
			Heavy								115%	110%	105%	100%		7894	(17,403)
		2.1	Log/Agg						115%	110%	105%	100%				8257	(18,204)
			Heavy					115%	110%	105%	100%					7836	(17,275)
		2.3	Log/Agg			115%	110%	105%	100%							8156	(17,980)
			Heavy		115%	110%	105%	100%								7737	(17,057)
	Fusion	1.9	Log/Agg								115%	110%	105%	100%		7942	(17,509)
			Heavy								115%	110%	105%	100%		7524	(16,587)
		2.1	Log/Agg					115%	110%	105%	100%					7862	(17,333)
			Heavy				115%	110%	105%	100%						7445	(16,413)
		2.3	Log/Agg			115%	110%	105%	100%							7783	(17,159)
			Heavy		115%	110%	105%	100%								7371	(16,250)
930M	Pin On	2.1	Log/Agg								115%	110%	105%	100%		9295	(20,491)
			Heavy								115%	110%	105%	100%		8873	(19,561)
			Standard						115%	110%	105%	100%				8366	(18,444)
		2.3	Log/Agg						115%	110%	105%	100%				9186	(20,252)
			Heavy					115%	110%	105%	100%					8769	(19,332)
			Standard			115%	110%	105%	100%							8262	(18,213)
	Fusion	2.5	Log/Agg					115%	110%	105%	100%					9055	(19,962)
			Heavy				115%	110%	105%	100%						8639	(19,045)
			Standard		115%	110%	105%	100%								8135	(17,934)
		2.1	Log/Agg							115%	110%	105%	100%			8883	(19,583)
			Heavy							115%	110%	105%	100%			8469	(18,670)
		2.3	Log/Agg					115%	110%	105%	100%					8804	(19,410)
	Heavy				115%	110%	105%	100%						8390	(18,497)		
	Log/Agg			115%	110%	105%	100%							8690	(19,158)		
	Heavy		115%	110%	105%	100%								8278	(18,249)		
938M	Pin On	2.5	Log/Agg								115%	110%	105%	100%		10 925	(24,085)
			Heavy								115%	110%	105%	100%		10 517	(23,186)
			Standard						115%	110%	105%	100%				10 015	(22,079)
		2.7	Log/Agg						115%	110%	105%	100%				10 832	(23,881)
			Heavy					115%	110%	105%	100%					10 426	(22,985)
			Standard			115%	110%	105%	100%							9925	(21,881)
	Fusion	2.9	Log/Agg					115%	110%	105%	100%					10 753	(23,706)
			Heavy				115%	110%	105%	100%						10 350	(22,817)
			Standard		115%	110%	105%	100%								9854	(21,724)
		2.5	Log/Agg							115%	110%	105%	100%			10 430	(22,994)
			Heavy							115%	110%	105%	100%			10 028	(22,107)
		2.7	Log/Agg					115%	110%	105%	100%					10 341	(22,798)
	Heavy				115%	110%	105%	100%						9938	(21,909)		
2.9	Log/Agg			115%	110%	105%	100%							10 266	(22,632)		
	Heavy		115%	110%	105%	100%								9864	(21,746)		

Material density, fill factor, and counterweight options are key variables when choosing the appropriate size of the bucket. The long floor and open throat design of the Performance Series Buckets along with the aggressive rack angles of the optimized linkage will demonstrate fill factors greater than 100% ISO rated. Refer to the expected fill factor % per material type at the top of the table and find a matching counterweight and fill factor along the side for proper bucket sizing.

*Full compliance to ISO 14397-1 (2007) Sections 1 thru 6, which requires 2% verification between calculation and testing.

Light Material Bucket Selection – Standard Lift

Material Type		Fill Factor %													Tip Load Full Turn*		
		100%	110%	115%	110%	110%	110%	110%	105%	105%	110%	110%	110%	110%			110%
926M	Pin On	m ³	Counter-weight	kg/m ³	805	850	895	940	985	1030	1075	1120	1165	1210	1255	kg	lb
		yd ³	lb/yd ³	(1,356)	(1,432)	(1,508)	(1,584)	(1,660)	(1,736)	(1,811)	(1,887)	(1,963)	(2,039)	(2,115)			
926M	Pin On	3.1	(4.1)	Log/Agg							115%	110%	105%	100%	7880	(17,372)	
				Heavy						115%	110%	105%	100%	7463	(16,453)		
		3.5	(4.6)	Log/Agg				115%	110%	105%	100%					7735	(17,052)
				Heavy			115%	110%	105%	100%					7321	(16,140)	
		3.8	(5.0)	Log/Agg			115%	110%	105%	100%						7600	(16,755)
				Heavy		115%	110%	105%	100%						7190	(15,850)	
	Fusion	3.1	(4.1)	Log/Agg							115%	110%	105%	100%		7533	(16,607)
				Heavy						115%	110%	105%	100%		7124	(15,705)	
		3.5	(4.6)	Log/Agg				115%	110%	105%	100%					7364	(16,234)
				Heavy			115%	110%	105%	100%					6957	(15,337)	
		3.8	(5.0)	Log/Agg		115%	110%	105%	100%							7235	(15,950)
				Heavy		110%	105%	100%							6830	(15,057)	
930M	Pin On	3.5	(4.6)	Log/Agg						115%	110%	105%	100%		8750	(19,290)	
				Heavy						115%	110%	105%	100%		8337	(18,379)	
		3.8	(5.0)	Log/Agg				115%	110%	105%	100%					8603	(18,966)
				Heavy			115%	110%	105%	100%					8198	(18,073)	
		4.2	(5.5)	Log/Agg			115%	110%	105%	100%						8484	(18,704)
				Standard		110%	105%	100%							8077	(17,806)	
	Fusion	3.5	(4.6)	Log/Agg					115%	110%	105%	100%				8365	(18,441)
				Heavy					115%	110%	105%	100%			7960	(17,548)	
		3.8	(5.0)	Log/Agg				115%	110%	105%	100%					8231	(18,145)
				Heavy			115%	110%	105%	100%					7825	(17,251)	
		4.2	(5.5)	Log/Agg		115%	110%	105%	100%							8106	(17,870)
				Heavy		115%	110%	105%	100%						7707	(16,991)	
938M	Pin On	3.8	(5.0)	Log/Agg							115%	110%	105%	100%	10 412	(22,954)	
				Heavy							115%	110%	105%	100%	10 015	(22,079)	
		4.2	(5.5)	Log/Agg					115%	110%	105%	100%				9523	(20,994)
				Standard					115%	110%	105%	100%			10 265	(22,630)	
		5.0	(6.5)	Log/Agg			115%	110%	105%	100%						9870	(21,759)
				Standard		115%	110%	105%	100%						9383	(20,685)	
	Fusion	3.8	(5.0)	Log/Agg							115%	110%	105%	100%		9933	(21,898)
				Heavy						115%	110%	105%	100%		9542	(21,036)	
		4.2	(5.5)	Log/Agg					115%	110%	105%	100%				9811	(21,629)
				Heavy				115%	110%	105%	100%				9416	(20,759)	
		5.0	(6.5)	Log/Agg		115%	110%	105%	100%							9770	(21,539)
				Heavy		115%	110%	105%	100%						9383	(20,685)	

Material density, fill factor, and counterweight options are key variables when choosing the appropriate size of the bucket. The long floor and open throat design of the Performance Series Buckets along with the aggressive rack angles of the optimized linkage will demonstrate fill factors greater than 100% ISO rated. Refer to the expected fill factor % per material type at the top of the table and find a matching counterweight and fill factor along the side for proper bucket sizing.

*Full compliance to ISO 14397-1 (2007) Sections 1 thru 6, which requires 2% verification between calculation and testing.

Bucket Selection Tables

General Purpose Bucket Selection – High Lift

Material Type		Fill Factor %														Tip Load Full Turn*					
		Fertilizer, Mixed		Coal Anthracite, Washed		Gypsum, Pulverized		Peat, Wet		Coal Anthracite, Raw		Earth, Loam, Dry		Salt, Fine				Heavy Metal Scrap, Loose		Shale	
Fill Factor %		m ³	yd ³	Counter-weight	kg/m ³	lb/yd ³	1030	1075	1120	1165	1210	1255	1300	1345	1390	1435	1480	kg	lb		
926M High Lift	Pin On	1.9	(2.5)	Log/Agg	Not Available														5970	(13,161)	
				Heavy	115%																
		2.1	(2.7)	Log/Agg	Not Available														5926	(13,065)	
				Heavy	115% 110% 105% 100%																
		2.3	(3.0)	Log/Agg	Not Available														5837	(12,869)	
				Heavy	115% 110% 105% 100%																
	Fusion	1.9	(2.5)	Log/Agg	Not Available														5628	(12,407)	
				Heavy	115% 110% 105% 100%																
		2.1	(2.7)	Log/Agg	Not Available														5561	(12,259)	
				Heavy	115% 110% 105% 100%																
		2.3	(3.0)	Log/Agg	Not Available														5497	(12,118)	
				Heavy	115% 110% 105% 100%																
930M High Lift	Pin On	2.1	(2.7)	Log/Agg	Not Available														6384	(14,074)	
				Heavy	115% 110% 105% 100%																
		2.3	(3.0)	Log/Agg	Not Available														6297	(13,883)	
				Heavy	115% 110% 105% 100%																
		2.5	(3.3)	Log/Agg	Not Available														6185	(13,635)	
				Heavy	115% 110% 105% 100%																
	Fusion	2.1	(2.7)	Log/Agg	Not Available														6014	(13,259)	
				Heavy	115% 110% 105% 100%																
		2.3	(3.0)	Log/Agg	Not Available														5952	(13,122)	
				Heavy	115% 110% 105% 100%																
		2.5	(3.3)	Log/Agg	Not Available														5860	(12,919)	
				Heavy	115% 110% 105% 100%																
938M High Lift	Pin On	2.5	(3.3)	Log/Agg	Not Available														7370	(16,248)	
				Heavy	115% 110% 105% 100%																
		2.7	(3.5)	Log/Agg	Not Available														7301	(16,095)	
				Heavy	115% 110% 105% 100%																
		2.9	(3.8)	Log/Agg	Not Available														7244	(15,970)	
				Heavy	115% 110% 105% 100%																
	Fusion	2.5	(3.3)	Log/Agg	Not Available														6940	(15,300)	
				Heavy	115% 110% 105% 100%																
		2.7	(3.5)	Log/Agg	Not Available														6869	(15,143)	
				Heavy	115% 110% 105% 100%																
		2.9	(3.8)	Log/Agg	Not Available														6815	(15,024)	
				Heavy	115% 110% 105% 100%																

Material density, fill factor, and counterweight options are key variables when choosing the appropriate size of the bucket. The long floor and open throat design of the Performance Series Buckets along with the aggressive rack angles of the optimized linkage will demonstrate fill factors greater than 100% ISO rated. Refer to the expected fill factor % per material type at the top of the table and find a matching counterweight and fill factor along the side for proper bucket sizing.

*Full compliance to ISO 14397-1 (2007) Sections 1 thru 6, which requires 2% verification between calculation and testing.

Light Material Bucket Selection – High Lift

Material Type		Fill Factor %														Tip Load Full Turn*				
		115%	115%	110%	115%	100%	100%	100%	100%	110%	100%	100%	105%	100%	110%			110%	115%	110%
926M High Lift	Pin On	m ³	Counter-weight	kg/m ³	550	580	610	640	670	700	730	760	790	820	850	kg	lb			
		yd ³	lb/yd ³	(927)	(977)	(1,028)	(1,078)	(1,129)	(1,180)	(1,230)	(1,281)	(1,331)	(1,382)	(1,432)						
926M High Lift	Pin On	3.1 (4.1)	Log/Agg Heavy	Not Available									115%	110%	105%	100%	5587	(12,317)		
		3.5 (4.6)	Log/Agg Heavy	Not Available				115%	110%	105%	100%						5467	(12,052)		
		3.8 (5.0)	Log/Agg Heavy	Not Available														5358	(11,812)	
		3.1 (4.1)	Log/Agg Heavy	Not Available							115%	110%	105%	100%				5273	(11,625)	
		3.5 (4.6)	Log/Agg Heavy	Not Available				115%	110%	105%	100%							5124	(11,296)	
		3.8 (5.0)	Log/Agg Heavy	Not Available	115%	110%	105%	100%										5024	(11,075)	
	930M High Lift	Pin On	3.5 (4.6)	Log/Agg Heavy	Not Available													5929	(13,071)	
			3.8 (5.0)	Log/Agg Heavy	Not Available													5544	(12,222)	
			4.2 (5.5)	Log/Agg Heavy	Not Available														5729	(12,629)
			3.5 (4.6)	Log/Agg Heavy	Not Available							115%	110%	105%	100%				5586	(12,315)
			3.8 (5.0)	Log/Agg Heavy	Not Available														5480	(12,080)
			4.2 (5.5)	Log/Agg Heavy	Not Available	115%	110%	105%	100%										5384	(11,870)
938M High Lift		Pin On	3.8 (5.0)	Log/Agg Heavy	Not Available															
			4.2 (5.5)	Log/Agg Heavy	Not Available															
			5.0 (6.5)	Log/Agg Heavy	Not Available															
			3.8 (5.0)	Log/Agg Heavy	Not Available															
			4.2 (5.5)	Log/Agg Heavy	Not Available															
			5.0 (6.5)	Log/Agg Heavy	Not Available															
	Fusion	3.8 (5.0)	Log/Agg Heavy	Not Available																
		4.2 (5.5)	Log/Agg Heavy	Not Available																
		5.0 (6.5)	Log/Agg Heavy	Not Available																
		3.8 (5.0)	Log/Agg Heavy	Not Available																
		4.2 (5.5)	Log/Agg Heavy	Not Available																
		5.0 (6.5)	Log/Agg Heavy	Not Available																

Material density, fill factor, and counterweight options are key variables when choosing the appropriate size of the bucket. The long floor and open throat design of the Performance Series Buckets along with the aggressive rack angles of the optimized linkage will demonstrate fill factors greater than 100% ISO rated. Refer to the expected fill factor % per material type at the top of the table and find a matching counterweight and fill factor along the side for proper bucket sizing.

*Full compliance to ISO 14397-1 (2007) Sections 1 thru 6, which requires 2% verification between calculation and testing.

Operating Specifications

Operating Specifications with Forks

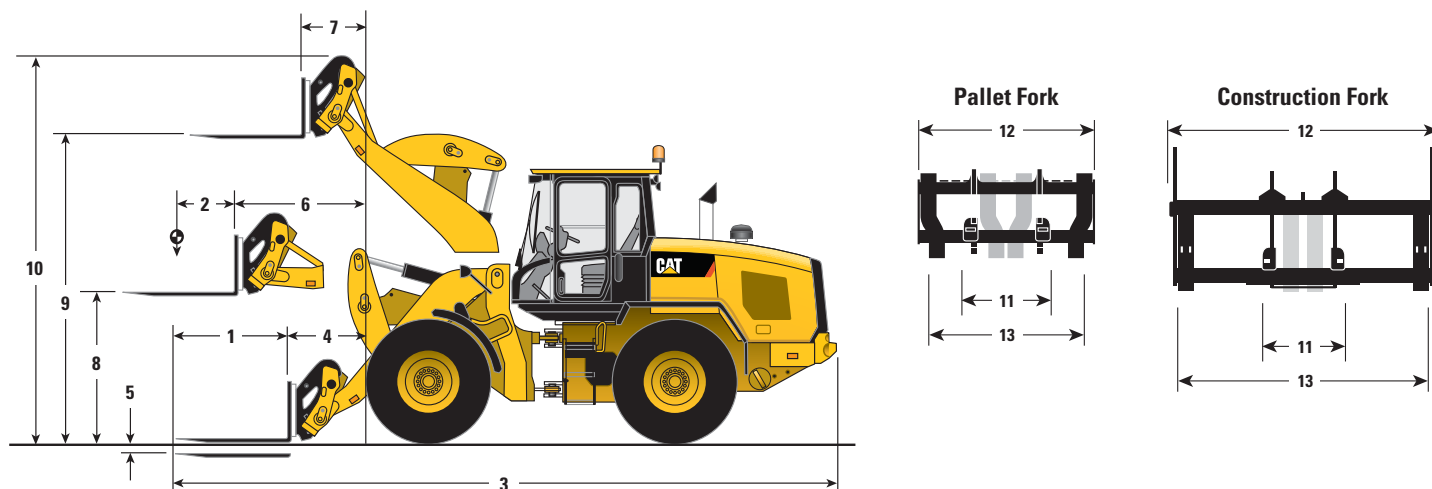

	Pallet Fork – Fusion						Construction Fork – Fusion					
	926M		930M		938M		926M		930M		938M	
	mm	ft/in	mm	ft/in	mm	ft/in	mm	ft/in	mm	ft/in	mm	ft/in
1 Fork tine length	1220	4'0"	1220	4'0"	1220	4'0"	1524	5'0"	1524	5'0"	1524	5'0"
2 Load center	610	2'0"	610	2'0"	610	2'0"	762	2'6"	762	2'6"	762	2'5"
3 Length: overall	7875	25'10"	7882	25'10"	7942	26'0"	8298	27'2"	8305	27'2"	8366	27'5"
4 Reach: ground	926	3'0"	926	3'0"	961	3'1"	1045	3'5"	1045	3'5"	1081	3'6"
5 Dig depth	47	1.9"	47	1.9"	44	1.7"	120	4.7"	120	4.7"	119	4.7"
6 Reach: level arm	1569	5'1"	1569	5'1"	1617	5'3"	1627	5'4"	1627	5'4"	1675	5'5"
7 Reach: full lift	767	2'6"	767	2'6"	814	2'8"	825	2'8"	825	2'8"	872	2'10"
8 Clearance: level arm	1792	5'10"	1792	5'10"	1830	6'0"	1729	5'8"	1729	5'8"	1766	5'9"
9 Clearance: full lift	3693	12'1"	3693	12'1"	3758	12'3"	3630	11'10"	3630	11'10"	3693	12'1"
10 Height: overall	4676	15'4"	4676	15'4"	4740	15'6"	4935	16'2"	4935	16'2"	0	0'0"
11 Minimum fork spacing	300	0'11"	300	0'11"	300	0'11"	300	0'11"	300	0'11"	300	0'11"
12 Carriage width	1566	5'1"	1566	5'1"	1566	5'1"	2498	8'2"	2498	8'2"	2498	8'2"
13 Maximum fork spacing	1550	5'1"	1550	5'1"	1550	5'1"	2375	7'9"	2375	7'9"	2375	7'9"
	kg	lb	kg	lb	kg	lb	kg	lb	kg	lb	kg	lb
Tipping load – straight, ISO 14397-1*	6756	14,895	7689	16,951	9274	20,445	6049	13,335	6919	15,254	8405	18,528
Tipping load – full turn, ISO 14397-1*	5807	12,801	6577	14,499	7909	17,437	5168	11,394	5887	12,978	7136	15,731
Operating weight	12 759	28,129	13 671	30,140	15 932	35,123	13 094	28,866	14 006	30,877	16 266	35,861
Rated load % of full turn tip:												
50% of tip: SAE J1197**	2903	6,400	3288	7,249	3955	8,718	2584	5,697	2943	6,489	3568	7,865
60% of tip: rough terrain EN474-3**	3484	7,680	3946	8,699	4746	10,462	3101	6,836	3532	7,786	4281	9,438
80% of tip: firm and level EN474-3**	4645	10,240	5261	11,599	6327	13,949	4135	9,115	4709	10,382	5708	12,584

*Full compliance to ISO 14397-1 (2007) Sections 1 thru 6, which requires 2% verification between calculation and testing.

**Full compliance to EN474-3 and SAE J1197.

Operating Specifications with Material Handling Arm

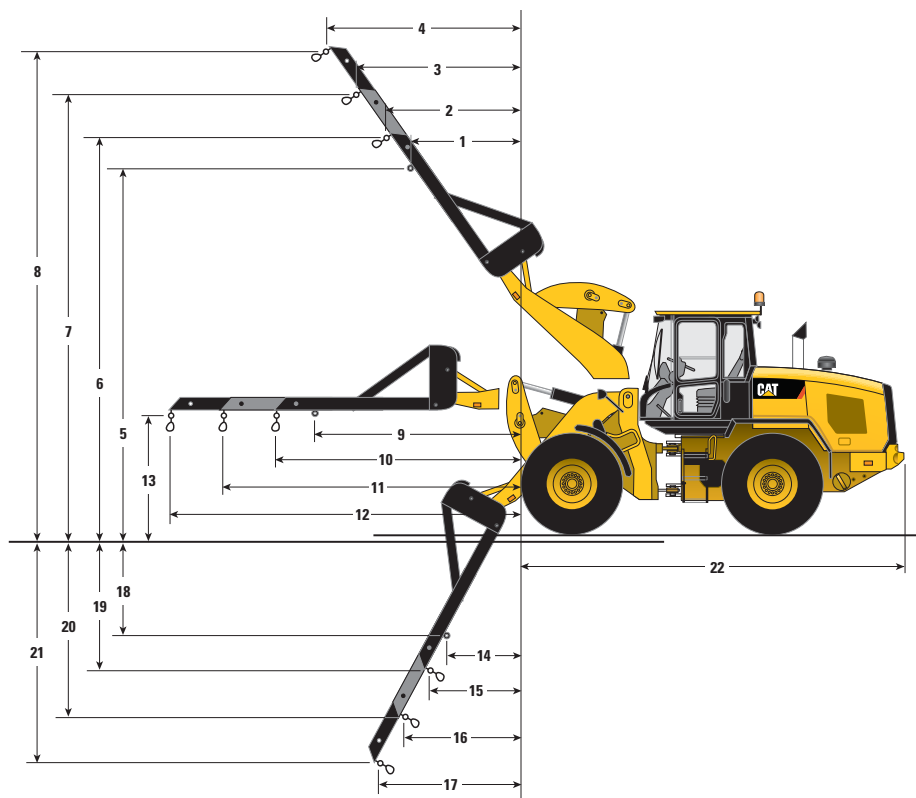

Material Handling Arm – Fusion

	926M		930M		938M			926M		930M		938M	
1	2113 mm	6'11"	2113 mm	6'11"	2144 mm	7'0"	12	5327 mm	17'5"	5327 mm	17'5"	5376 mm	17'7"
2	2333 mm	7'7"	2333 mm	7'7"	2362 mm	7'8"	13	1854 mm	6'0"	1854 mm	6'0"	1890 mm	6'2"
3	2919 mm	9'6"	2919 mm	9'6"	2943 mm	9'7"	14	863 mm	2'9"	863 mm	2'9"	906 mm	2'11"
4	3505 mm	11'6"	3505 mm	11'6"	3525 mm	11'6"	15	1045 mm	3'5"	1045 mm	3'5"	1089 mm	3'6"
5	5257 mm	17'2"	5257 mm	17'2"	5343 mm	17'6"	16	1276 mm	4'2"	1276 mm	4'2"	1324 mm	4'4"
6	5568 mm	18'3"	5568 mm	18'3"	5655 mm	18'6"	17	1507 mm	4'11"	1507 mm	4'11"	1559 mm	5'1"
7	6112 mm	20'0"	6112 mm	20'0"	6204 mm	20'4"	18	1975 mm	6'5"	1975 mm	6'5"	1983 mm	6'6"
8	6657 mm	21'10"	6657 mm	21'10"	6754 mm	22'1"	19	2310 mm	7'6"	2310 mm	7'6"	2316 mm	7'7"
9	3354 mm	11'0"	3354 mm	11'0"	3403 mm	11'1"	20	3076 mm	10'1"	3076 mm	10'1"	3081 mm	10'1"
10	3727 mm	12'2"	3727 mm	12'2"	3775 mm	12'4"	21	3842 mm	12'7"	3842 mm	12'7"	3846 mm	12'7"
11	4527 mm	14'10"	4527 mm	14'10"	4575 mm	15'0"	22	5730 mm	18'9"	5737 mm	18'9"	5762 mm	18'10"

	926M		930M		938M	
Operating weight	12 626 kg	27,835 lb	13 538 kg	29,847 lb	15 799 kg	34,830 lb
Rated load* (50% of full turn tip** SAE J1197)						
Fixed tab (9)	2081 kg	4,588 lb	2356 kg	5,193 lb	2844 kg	6,269 lb
Minimum extension (10)	1908 kg	4,205 lb	2159 kg	4,760 lb	2610 kg	5,753 lb
Middle extension (11)	1618 kg	3,567 lb	1832 kg	4,037 lb	2217 kg	4,887 lb
Maximum extension (12)	1405 kg	3,097 lb	1590 kg	3,505 lb	1927 kg	4,248 lb

*Full compliance to ISO 14397-1 (2007) Sections 1 thru 6, which requires 2% verification between calculation and testing.

**Full compliance to EN474-3 and SAE J1197.

Operating Specifications

Operating Specifications with High Dump Buckets



		Pin On			Fusion			ISO 23727			High Lift		
		926M	930M	938M	926M	930M	938M	926M	930M	938M	926M	930M	938M
Rated Capacity	m ³	3.0	3.5	4.1	3.0	3.5	4.1	3.0	3.5	4.1	–	–	–
	yd ³	4.0	4.6	5.4	3.9	4.6	5.4	3.9	4.6	5.4	–	–	–
Capacity – Rated at 110%	m ³	3.3	3.9	4.5	3.3	3.9	4.5	3.3	3.9	4.5	–	–	–
Fill Factor	yd ³	4.4	5.0	5.9	4.3	5.0	5.9	4.3	5.0	5.9	–	–	–
Bucket Width	mm	2528	2728	3030	2528	2728	3032	2528	2728	3032	–	–	–
	ft/in	8'3"	8'11"	9'11"	8'3"	8'11"	9'11"	8'3"	8'11"	9'11"	–	–	–
Nominal Material Density	kg/m ³	962	946	1062	954	915	916	885	867	878	–	–	–
	110% Fill Factor lb/yd ³	1,604	1,605	1,790	1,615	1,553	1,544	1,498	1,473	1,480	–	–	–
1 Length: Overall	mm	7907	7914	8044	7913	7986	8126	8176	8183	8313	+642	+794	+737
	ft/in	25'11"	25'11"	26'4"	25'11"	26'2"	26'7"	26'9"	26'10"	27'3"	+2'1"	+2'7"	+2'5"
2 Dump Clearance: Full Lift Rolled Out	mm	4252	4252	4264	4275	4332	4354	4399	4523	4539	+440	+568	+545
	ft/in	13'11"	13'11"	13'11"	14'0"	14'2"	14'3"	14'5"	14'10"	14'10"	+1'5"	+1'10"	+1'9"
3 Clearance: Level Bucket	mm	4592	4592	4647	4606	4609	4725	4751	4849	4904	+451	+574	+553
	ft/in	15'0"	15'0"	15'2"	15'1"	15'1"	15'6"	15'7"	15'10"	16'1"	+1'5"	+1'10"	+1'9"
4 Height: Overall	mm	6255	6298	6367	6268	6315	6446	6413	6555	6605	+451	+574	+553
	ft/in	20'6"	20'7"	20'10"	20'6"	20'8"	21'1"	21'0"	21'6"	21'8"	+1'5"	+1'10"	+1'9"
5 Reach: Full Lift Rolled Out	mm	1425	1425	1489	1421	1458	1530	1613	1561	1626	+253	+329	+278
	ft/in	4'8"	4'8"	4'10"	4'7"	4'9"	5'0"	5'3"	5'1"	5'4"	+0'9"	+1'0"	+0'10"
6 Dig Depth	mm	80	80	96	100	100	116	94	94	109	+35	+35	+35
	in	3.2"	3.2"	3.8"	3.9"	3.9"	4.6"	3.7"	3.7"	4.3"	+1.4"	+1.4"	+1.4"
7 Maximum Dump Angle	degree	52	52	51	50	49	49	55	48	48	–	–	–
8 Rack Angle at Carry	degree	43	43	55	45	45	46	43	43	44	–	–	–
Tipping Load – Straight ISO 14397-1*	kg	7560	8637	11 395	7465	8389	9903	6941	7967	9494	–1946	–2473	–3161***
	lb	16,666	19,041	25,120	16,457	18,495	21,832	15,301	17,564	20,931	–4,290	–5,450	–6,966
Tipping Load – Straight Rigid Tire**	kg	7875	8997	11 869	7776	8739	10 315	7230	8299	9890	–2027	–2576	–3292***
	lb	17,360	19,834	26,167	17,143	19,265	22,741	15,938	18,295	21,803	–4,469	–5,677	–7,256
Tipping Load – Full Turn ISO 14397-1*	kg	6404	7281	9580	6299	7043	8266	5844	6680	7921	–1717	–2171	–2742***
	lb	14,117	16,051	21,119	13,886	15,528	18,223	12,884	14,726	17,462	–3,784	–4,784	–6,043
Tipping Load – Full Turn Rigid Tire**	kg	6812	7746	10 191	6701	7493	8794	6217	7106	8426	–1826	–2309	–2917***
	lb	15,018	17,076	22,467	14,773	16,519	19,386	13,706	15,666	18,577	–4,026	–5,089	–6,429
Breakout Force	kg	6560	8584	9491	6727	8373	8959	5500	7258	7845	–361	–219	–369
	lb	14,463	18,925	20,923	14,829	18,458	19,750	12,125	16,000	17,295	–795	–482	–812
Operating Weight	kg	13 531	14 534	17 014	13 834	14 836	17 427	13 793	14 795	17 327	+278	+232	–102***
	lb	29,830	32,042	37,509	30,499	32,706	38,419	30,409	32,616	38,199	612	511	–224

*Full compliance to ISO 14397-1 (2007) Sections 1 thru 6, which requires 2% verification between calculation and testing.

**Compliance to ISO 14397-1 (2007) Sections 1 thru 5.

***938M High Lift is configured with standard counterweight.

High Dump Bucket Selection – Standard Lift

Material Type		Fill Factor %														Tip Load Full Turn*				
		Mulch, Wet	Municipal Solid Waste	Flour, Wheat	Compacted Solid Waste	Barley, Bulk	Asphalt, Crushed	Soy Beans, Bulk	Corn Shelled, Bulk	Glass, Semi Crushed	Bulk Grain	Construction and Demolition	Silage, Packed	Manure/Muck, Wet	Coal Bituminous, Washed			Peat, Moist	Coal Bituminous, Raw	Sugar, Raw Cane
926M	Pin On	m ³	yd ³	Counter-weight	kg/m ³	560	620	680	740	800	860	920	980	1040	1100	1160	kg	lb		
		926M	Pin On	3.0	(3.9)	Log/Agg								115%	110%	105%	100%		6792	(14,973)
Heavy														115%	110%	105%	100%		6404	(14,118)
3.5	(4.6)			Log/Agg							115%	110%	105%	100%					6720	(14,815)
				Heavy							115%	110%	105%	100%					6328	(13,950)
4.1	(5.4)			Log/Agg			115%	110%	105%	100%									6298	(13,883)
				Heavy		115%	110%	105%	100%										5913	(13,035)
Fusion	3.0		(3.9)	Log/Agg									115%	110%	105%	100%		6690	(14,748)	
				Heavy										115%	110%	105%	100%		6299	(13,886)
	3.5		(4.6)	Log/Agg						115%	110%	105%	100%					6482	(14,290)	
				Heavy					115%	110%	105%	100%						6097	(13,441)	
	4.1		(5.4)	Log/Agg			115%	110%	105%	100%									6076	(13,395)
				Heavy		115%	110%	105%	100%										5689	(12,542)
930M	Pin On	3.0	(3.9)	Log/Agg								115%	110%	105%	100%		7672	(16,913)		
				Heavy										115%	110%	105%	100%		7281	(16,051)
		3.5	(4.6)	Standard							115%	110%	105%	100%				6811	(15,015)	
				Log/Agg					115%	110%	105%	100%						7241	(15,962)	
		4.1	(5.4)	Heavy					115%	110%	105%	100%						6855	(15,113)	
				Standard			115%	110%	105%	100%								6396	(14,100)	
	Fusion	3.5	(4.6)	Log/Agg									115%	110%	105%	100%		7427	(16,373)	
				Heavy										115%	110%	105%	100%		7043	(15,527)
		4.1	(5.4)	Log/Agg						115%	110%	105%	100%					7011	(15,456)	
				Heavy					115%	110%	105%	100%						6634	(14,625)	
		5.0	(6.5)	Log/Agg			115%	110%	105%	100%									6860	(15,123)
				Heavy		115%	110%	105%	100%										6481	(14,288)
938M	Pin On	4.1	(5.4)	Log/Agg									115%	110%	105%	100%	9988	(22,018)		
				Heavy											115%	110%	105%	100%	9580	(21,120)
		5.0	(6.5)	Standard									115%	110%	105%	100%		9077	(20,012)	
				Log/Agg					115%	110%	105%	100%						8750	(19,290)	
		5.0	(6.5)	Heavy					115%	110%	105%	100%						8384	(18,483)	
				Standard			115%	110%	105%	100%								7930	(17,482)	
	Fusion	4.1	(5.4)	Log/Agg								115%	110%	105%	100%			8635	(19,036)	
				Heavy									115%	110%	105%	100%		8266	(18,222)	
		5.0	(6.5)	Log/Agg					115%	110%	105%	100%						8480	(18,695)	
				Heavy				115%	110%	105%	100%							8112	(17,883)	

Material density, fill factor, and counterweight options are key variables when choosing the appropriate size of the bucket. The long floor and open throat design of the Performance Series Buckets along with the aggressive rack angles of the optimized linkage will demonstrate fill factors greater than 100% ISO rated. Refer to the expected fill factor % per material type at the top of the table and find a matching counterweight and fill factor along the side for proper bucket sizing.

*Full compliance to ISO 14397-1 (2007) Sections 1 thru 6, which requires 2% verification between calculation and testing.

Bucket Selection Tables

High Dump Bucket Selection – High Lift

Material Type		Fill Factor %														Tip Load Full Turn*			
		115%	115%	115%	110%	105%	110%	115%	115%	110%	115%	110%	100%	110%	100%			105%	100%
926M High Lift	Pin On	m ³	Counter-weight	kg/m ³ lb/yd ³	Paper, Semi Compacted Yard Waste	Food Scraps	Glass, Whole Bottles Brewers Grain	Woodchips, Dry	Mulch, Wet	Municipal Solid Waste Flour, Wheat	Compacted Solid Waste Barley, Bulk	Asphalt, Crushed	Soy Beans, Bulk Corn Shelled, Bulk	Glass, Semi Crushed	Bulk Grain	kg	lb		
				yd ³	Log/Agg Heavy	Not Available													
	3.0 (3.9)		Log/Agg Heavy	Not Available								115%	110%	105%	100%		4736 (10,441)		
	3.5 (4.6)		Log/Agg Heavy	Not Available						115%	110%	105%	100%				4655 (10,262)		
	4.1 (5.4)		Log/Agg Heavy	Not Available													4272 (9,418)		
			Log/Agg Heavy	Not Available															
	3.0 (3.9)		Log/Agg Heavy	Not Available								115%	110%	105%	100%		4584 (10,105)		
	3.5 (4.6)		Log/Agg Heavy	Not Available						115%	110%	105%	100%				4424 (9,753)		
	4.1 (5.4)		Log/Agg Heavy	Not Available													4043 (8,912)		
			Log/Agg Heavy	Not Available															
930M High Lift	Pin On	3.5 (4.6)	Log/Agg Heavy	Not Available															
			Standard										115%	110%	105%	100%		5110 (11,265)	
			Log/Agg Heavy	Not Available															4746 (10,463)
			Standard																4723 (10,412)
			Log/Agg Heavy	Not Available															4362 (9,617)
			Standard																4560 (10,053)
	Fusion	5.0 (6.5)	Log/Agg Heavy	Not Available															
			Standard																4200 (9,259)
			Log/Agg Heavy	Not Available															4872 (10,740)
			Standard																4494 (9,906)
			Log/Agg Heavy	Not Available															4370 (9,634)
			Standard																
938M High Lift	Pin On	4.1 (5.4)	Log/Agg Heavy	Not Available															
			Standard																
			Log/Agg Heavy	Not Available															6412 (14,136)
			Standard																5700 (12,566)
			Log/Agg Heavy	Not Available															
			Standard																
	Fusion	4.1 (5.4)	Log/Agg Heavy	Not Available															
			Standard																
			Log/Agg Heavy	Not Available															5527 (12,184)
			Standard																5390 (11,882)
			Log/Agg Heavy	Not Available															
			Standard																

Material density, fill factor, and counterweight options are key variables when choosing the appropriate size of the bucket. The long floor and open throat design of the Performance Series Buckets along with the aggressive rack angles of the optimized linkage will demonstrate fill factors greater than 100% ISO rated. Refer to the expected fill factor % per material type at the top of the table and find a matching counterweight and fill factor along the side for proper bucket sizing.

*Full compliance to ISO 14397-1 (2007) Sections 1 thru 6, which requires 2% verification between calculation and testing.

Optional Equipment

	926M				930M				938M			
	Operating weight		Tipping load – full turn		Operating weight		Tipping load – full turn		Operating weight		Tipping load – full turn	
Change with options removed:	kg	lb	kg	lb	kg	lb	kg	lb	kg	lb	kg	lb
Heavy counterweight	N/A	N/A	N/A	N/A	-320	-705	-502	-1,107	-320	-705	-494	-1,089
Guard, crankcase	-11	-23	-16	-34	-11	-23	-13	-29	-11	-24	-17	-36
Guard, power train lower	-77	-170	-77	-168	-77	-170	-69	-151	-68	-150	-67	-146
Guard, driveshaft	-44	-96	-12	-26	-44	-96	-12	-26	-45	-100	-12	-27
Secondary steer	-69	-152	-75	-165	-69	-152	-73	-160	-69	-152	-74	-163
Ride control	-49	-108	-27	-59	-49	-108	-26	-57	-49	-108	-27	-59
Change with options added:												
Logger/Aggregate counterweight	+298	+656	+417	+919	+298	+656	+415	+914	+299	+659	+402	+886
Guard, front window	+34	+74	+17	+37	+34	+74	+18	+39	+34	+74	+18	+39
Guard, rear waste gate	N/A	N/A	N/A	N/A	+264	+582	+456	+1,005	+284	+626	+478	+1,053
Guard, power train side	+11	+24	+10	+22	+11	+24	+9	+19	+11	+24	+10	+22
Cold start package	+54	+119	+104	+229	+54	+119	+74	+163	+54	+119	+101	+222
Roading fenders	+18	+39	+28	+61	+18	+39	+24	+52	+18	+39	+28	+61

Tire Options



	926M				930M				938M			
	550/65 R25		17.5 R25 (L-3)		600/65 R25		20.5R25 (L-5)		23.5R25 R25*		Flexport**	
Change with tire option as compared to 20.5R25 L3 tire	mm	in	mm	in	mm	in	mm	in	mm	in	mm	in
Vertical heights	-70	-2.8"	-65	-2.6"	-15	-0.6"	+35	+1.4"	65	-2.6"	+59	+2.3"
Reach: bucket at 45°	+43	+1.7"	+73	+2.9"	+29	+1.1"	-21	-0.8"	-63	-2.5"	-23	-0.9"
Width: Over tires	+10	+0.4"	-69	-2.7"	+98	+3.9"	0	0"	+38	+1.5"	-12	-0.5"
Turning radius: Outside of tires	+0	+0"	-45	-1.8"	+42	+1.7"	+1	0"	+14	+0.6"	+23	+0.9"
	kg	lb	kg	lb	kg	lb	kg	lb	kg	lb	kg	lb
Tipping load – straight	-83	-182	-212	-466	+9	+19	+444	+978	+486	+1,071	+1564	+3,447
Tipping load – full turn	-72	-157	-183	-403	+8	+17	+384	+846	+421	+927	+1352	+2,979
Operating weight	-126	-277	-322	-709	+14	+30	+678	+1,494	+748	+1,648	+2405	+5,300

*938M compatible with standard counterweight for general construction and heavy counterweight for Aggregate or Forest Handlers.

**938M compatible with standard counterweight (Flexport) only.

Supplemental Specifications

Ground Engagement Options

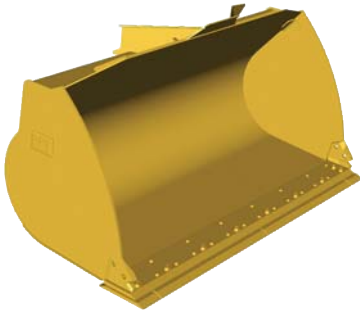

Bolt-on Cutting Edge

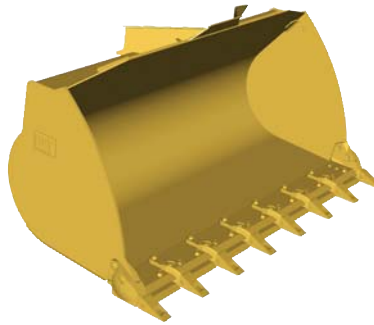

Long Teeth and Segments

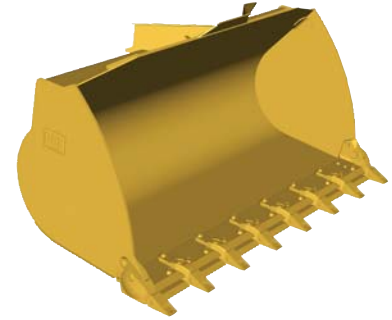

Short Teeth and Segments

Change with Ground Engagement option compared to Bolt-on Cutting Edge	926M				930M				938M			
	Long Teeth and Segments		Short Teeth and Segments		Long Teeth and Segments		Short Teeth and Segments		Long Teeth and Segments		Short Teeth and Segments	
	mm	in	mm	in	mm	in	mm	in	mm	in	mm	in
Dig depth	+12	+0.5"	+5	+0.2"	+11	+0.4"	+5	+0.2"	+11	+0.4"	+5	+0.2"
Length: overall	+146	+5.7"	+121	+4.8"	+146	+5.7"	+121	+4.8"	+146	+5.7"	+121	+4.8"
Dump clearance	-103	-4.1"	-82	-3.2"	-104	-4.1"	-83	-3.3"	-105	-4.1"	-84	-3.3"
Reach	+104	+4.1"	+89	+3.5"	+103	+4.1"	+88	+3.5"	+102	+4"	+87	+3.4"
	kg	lb	kg	lb	kg	lb	kg	lb	kg	lb	kg	lb
Tipping Load – straight	-148	-325	-142	-311	-150	-329	-143	-315	-138	-305	-132	-291
Tipping Load – full turn	-145	-318	-139	-305	-146	-322	-140	-309	-136	-298	-130	-285
Breakout force	-121	-266	-115	-254	-121	-266	-115	-254	-112	-245	-106	-234
Operating weight	+120	+264	+116	+255	+120	+264	+116	+255	+111	+244	+106	+233

Standard Equipment

Standard equipment may vary. Consult your Cat dealer for details.

POWER TRAIN

- Axle seal guards
- Auto idle shut down feature
- Cat C7.1 ACERT engine
 - Power Modes (Standard and Performance)
 - Power by Range (High Power in Range 4)
 - Turbocharged and aftercooled
 - Diesel particulate filter (Fit for Life)
- Coolant protection to –34° C (–29° F)
- Differential lock in front axle
- Dry type air cleaner
- Enclosed wet disc full hydraulic brakes
- Fuel priming pump, automatic
- Fuel water separator
- Hydraulically driven demand cooling fan
- Intelligent hydrostatic transmission
 - Power train modes
 - Directional Shift Aggressiveness
 - Rimpull control, adjust wheel torque
 - Creeper control, adjust ground speed
- Lubed for life driveshafts
- Parking brake, electric
- Wide spaced 6 fins per inch cooling package
- S-O-SSM sampling ports
- Throttle lock and maximum speed limiter

HYDRAULICS

- Automatic lift, lower and tilt kickouts
- Bucket and Fork Modes, adjustable in-cab
- Cylinder damping at kickout and end stops
- Fine Mode control in Fork Mode
- Hydraulic Response setting
- Load sensing hydraulics and steering
- Seat-mounted hydraulic joystick controls

ELECTRICAL

- Alternator, 115-amp, heavy duty
- 12V power supply in cab (2)
- Batteries, 1,000 CCA (2) 24 volt system
- Back-up alarm
- Emergency shutdown switch
- Heavy duty gear reduction starter
- Product Link PRO with subscription
- Remote jump start post
- Resettable critical function breakers

OPERATOR ENVIRONMENT

- 75 mm (3 in) retractable seat belt, with audible alarm and indicator
- Automatic temperature control
- Cab, enclosed and pressurized
- Cup holders
- External heated mirrors with lower parabolic
- Ground level cab door release

- Gauges
 - Digital hour, odometer, tachometer, ground speed and direction indicator
 - Engine coolant temperature gauge
 - Fuel and Diesel Exhaust Fluid level
 - Hydraulic oil temperature gauge
- Hydraulic control lockout
- Interior cab lighting, door and dome
- Interior rearview mirrors (2)
- Lunch box storage
- Operator warning system indicators
- Radio ready speakers
- Rear window defrost, electric
- Seat-mounted controls, adjustable
- Sliding glass on the side windows
- Column mounted multi function control – lights, wipers, turn signal
- Suspension seat, fabric
- Tilt and telescopic steering wheel
- Wet arm wiper/washer, front and rear

OTHER STANDARD EQUIPMENT

- Large-access enclosure doors
- Parallel lift loader linkage
- Recovery hitch with pin
- Remote mounted lubrication points
- Lockable compartments and enclosures

Optional Equipment

Optional equipment may vary. Consult your Cat dealer for details.

- Antifreeze/coolant, extended-life
- Auto lube, integrated in secondary display
- Auxiliary flow, third and fourth function
- Axles, differential, limited slip, rear
- Beacon light, strobe
- Cab, deluxe (standard in Europe):
 - Automatic blower control
 - Electrically adjustable heated mirrors (2)
 - LED interior lighting
 - Secondary display to adjust settings
- Ride control adjustable speed activation
- Preventative maintenance reminders
- Integrated help function (26 languages)
 - Sunscreen, front and rear
- Camera, rearview (standard in Europe)
- Cold start package:
 - Ether starting aid, block heater and additional batteries, 1,000 CCA (4 total)
- Counterweight, (heavy and logger)
- Coupler, (Fusion and ISO 23727)
- Debris packages (low, medium, high)
- Fenders (extended cover and full coverage)
- Guards
 - Power train, (lower, side, driveshaft and crankcase)
 - Windshield and lights
 - Cylinders, tilt and steering
 - Rear radiator, heavy duty
- Linkage, high lift
- Lights, auxiliary, halogen or LED with engine compartment lights
- Object Detection
- Radio packages:
 - Radio ready with Bluetooth
 - Radio, AM/FM with Bluetooth and clock
 - Radio, AM/FM with CD player deluxe, weatherband, Bluetooth and clock
- Seats:
 - Deluxe seat – fully adjustable fabric air suspension seat with mid seat backrest
 - Premium seat – fully adjustable leather and fabric air suspension with high backrest and air lumbar support. Heated and cooled bottom cushion and backrest.
- Steering:
 - Dual mode and Secondary
- Tires:
 - Bias ply, 17.5, 20.5-25, Skidder
 - Radial, 17.5, 20.5, 23.5, 550/65, 600/65, 650/65 R25
 - Flexport, 620/65, 750/65 Agriculture
- Work tools

For more complete information on Cat products, dealer services, and industry solutions, visit us on the web at www.cat.com

AEHQ7475 (06-2015)

© 2015 Caterpillar
All rights reserved

Materials and specifications are subject to change without notice. Featured machines in photos may include additional equipment. See your Cat dealer for available options.

CAT, CATERPILLAR, SAFETY.CAT.COM, their respective logos, "Caterpillar Yellow" and the "Power Edge" trade dress, as well as corporate and product identity used herein, are trademarks of Caterpillar and may not be used without permission.

VisionLink is a trademark of Trimble Navigation Limited, registered in the United States and in other countries.

